

POLARIS RZR

2022

ACCESSORIES + APPAREL



OUTRUN

THE ORDINARY.



#RZRLife

LIVE THE LIFESTYLE.
JOIN THE COMMUNITY.

2022 LINEUP

TRAIL

TRAIL S & TRAIL

P. 42



RZR TRAIL S

570

P. 92



RZR 570

MULTI-TERRAIN

PRO XP

P. 04



RZR PRO XP SPORT



RZR PRO XP ULTIMATE

XP 1000 & RS1

P. 34



RZR XP 1000



RZR XP 4 1000

WIDE OPEN

PRO R & TURBO R

P. 04



RZR PRO R



RZR PRO R 4



RZR TURBO R



RZR TURBO R 4

YOUTH

P. 93

CONTENTS

PRO R, TURBO R & PRO XP 04

AUDIO	16
WINDSHIELDS & REAR PANELS.....	18
ROOFS, DOORS & HEATER.....	20
VEHICLE PROTECTION	22
LIGHTING.....	24
STORAGE	26
MISC, MIRRORS & WINCHES.....	28

XP 1000, XP TURBO & TURBO S 30

WINDSHIELDS, REAR PANELS & DOORS	31
ROOFS, VEHICLE PROTECTION & WINCHES....	32
STORAGE & MIRRORS.....	34
RS1 ACCESSORIES.....	36

TRAIL 38

WINDSHIELDS & REAR PANELS.....	42
ROOFS, DOORS & AUDIO.....	44
VEHICLE PROTECTION & STORAGE	46
WINCHES, HEATER & PLOWS	48
LIGHTING & ELECTRICAL & TRACKS.....	50

2014-2020 TRAIL 52

COMMON ACCESSORIES 54

LIGHTING.....	54
CONNECTED TECHNOLOGY.....	60
AUDIO	62
PRO ARMOR WHEELS & TIRES.....	64
VEHICLE & RIDER PROTECTION	80
POLARIS NORTHSTAR COOLERS.....	82
COCKPIT ACCESSORIES & MIRRORS.....	84
WINCHES	86
ADDITIONAL ACCESSORIES & 570	88

YOUTH 89

PARTS & GARAGE 90

MAINTENANCE.....	90
OIL & LUBRICANTS.....	92
HD PARTS.....	94
SERVICE PARTS.....	96
CLEANERS & TRAILERING.....	98

APPAREL 100

RIDING GEAR	104
HELMETS & GOGGLES	106
MEN'S APPAREL.....	108
WOMEN'S APPAREL	116
MERCHANDISE	118

DESIGNED



Designed by the same people who designed your vehicle.

TESTED



Extensively tested in the field so you ride with 100% confidence.

TRUSTED



65 years in the business. The #1 name in Off-Road.

WE HOLD OUR PARTNERS TO THE SAME STANDARDS



PREMIUM AFTERMARKET OPTIONS
DESIGNED WITH POLARIS TO
MAXIMIZE PERFORMANCE
P. 59, 64



A GLOBAL LEADER IN
AUDIO INNOVATION,
DESIGN & ENGINEERING
P. 16, 45



IGNITE AND FUEL YOUR PASSION
FOR PRECISE QUALITY SOUND
REPRODUCTION
P. 62



PRODUCTS SO GOOD
THEY REPLACE OR REPAIR
THEM FOR LIFE
P. 24, 58



MILITARY-GRADE AIR FILTRATION
THAT KEEPS YOUR AIR FILTER CLEAN
AND ENGINE PROTECTED
P. 28



RACE PROVEN.
TRAIL READY.
P. 28

INTRODUCING THE NEW

POLARIS RZR PRO R



POWER | STRENGTH | CONTROL



RIGID CHASE LIGHT
SEE P.25

> OPTIMAL PERFORMANCE

Easy customization solutions designed to fit perfectly and mount effortlessly.

ROCKFORD FOSGATE® AUDIO P.16
PROTECTION P.22
RIGID® LIGHTING P.24
POLARIS PULSE P.25



PLUG & PLAY ELECTRICAL

EFFORTLESSLY ADD
LIGHTS, AUDIO & WINCH



> TOTAL RELIABILITY

Personalized comfort with end-to-end protection from the elements.

WINDSHIELDS P.19
REAR PANELS P.19
DOORS P.21



> UNRIVALED FLEXIBILITY

Accessory options to give you even more reason to get out and stay riding.

STORAGE P.26
COOLERS P.27
PRO ARMOR WHEELS & TIRES P.64

> COLLECTIONS



DESERT

DUNE

RUGGED TRAIL

PRO R, TURBO R & PRO XP

AUDIO

WINDSHIELDS & REAR PANELS

ROOFS, DOORS & HEATER

VEHICLE PROTECTION

LIGHTING

STORAGE

MISC. MIRRORS & WINCHES

Dominate rocky environments and charge through endless miles of hard-pack terrain.

2884747	LOCK & RIDE FULL VENTED WINDSHIELD - HARD COAT POLY, 4-SEAT	P. 19
2884325-458	ALUMINUM ROOF, 4-SEAT*	P. 20
2884660-458	ALUMINUM DOORS, 4-SEAT	P. 21
2884355-293	FRONT PRE RUNNER WINCH BUMPER	P. 23
2884358-293	REAR PRE RUNNER BUMPER	P. 23
2889209-293	HD EXTREME KICK-OUT ROCK SLIDERS, 4-SEAT	P. 23
2883763	PREMIUM CONVEX REARVIEW MIRROR	P. 28
2883762	ADJUSTABLE FOLDING SIDE MIRRORS	P. 28
2884648	RIGID® SR-SERIES 32" COMBO LED LIGHT BAR	P. 24
2884601	32" LIGHT BAR MOUNT	P. 24
2889130	POLARIS PULSE HD LIGHT BAR HARNESS	P. 24
2884359	RIGID® CHASE LIGHT	P. 25
2884896	CHASE LIGHT MOUNT KIT	P. 25
2889034	CHASE LIGHT HARNESS KIT	P. 25
2884236	LOCK & RIDE 34L REAR CARGO BOX	P. 26
2883424	POLARIS NORTHSTAR 28L COOLER	P. 27
2889200	LOCK & RIDE NORTHSTAR 28L COOLER BRACKET	P. 27
2884326-458	PIVOTING SPARE TIRE CARRIER	P. 27
2884341	POLARIS PRO HD 6,000 LB WINCH	P. 29
2885012	PRO ARMOR WHEEL & TIRE SET: 5302 & PRO RUNNER, 33"	P. 78
5417533	PRO ARMOR SPARE TIRE: PRO RUNNER, 33"	P. 69
1524038	PRO ARMOR SPARE WHEEL: 5302, 15"	P. 76

Shown on Pro R 4-Seat.
*Aluminum roof comes stock on Premium/Ultimate models.

Carve through the soft sands and tackle each hill with confidence.

2884746	LOCK & RIDE HALF WINDSHIELD - HARD COAT POLY, LOW	P. 19
2884325-458	ALUMINUM ROOF, 4-SEAT*	P. 20
2884660-458	ALUMINUM DOORS, 4-SEAT	P. 21
2884354-458	FRONT PRE RUNNER BUMPER	P. 23
2884646	ASSAULT GRILL	P. 28
2883763	PREMIUM CONVEX REARVIEW MIRROR	P. 28
2884624	ASSAULT BOMBER MIRRORS	P. 28
2883857	STAGE 3 AUDIO UPGRADE BY ROCKFORD FOSGATE®	P. 16
2883945	REAR SPEAKER PODS BY ROCKFORD FOSGATE®	P. 16
2884648	RIGID® SR-SERIES 32" COMBO LED LIGHT BAR	P. 24
2884601	32" LIGHT BAR MOUNT	P. 24
2889130	POLARIS PULSE HD LIGHT BAR HARNESS	P. 24
2884359	RIGID® CHASE LIGHT	P. 25
2884896	CHASE LIGHT MOUNT KIT	P. 25
2889034	CHASE LIGHT HARNESS KIT	P. 25
2884235	LOCK & RIDE 57L FORWARD CARGO BOX	P. 26
2889740	LOCK & RIDE 22L REAR COOLER	P. 27
2884304	7L DOOR STORAGE BAG	P. 27
2885020	PRO ARMOR WHEEL & TIRE SET: 5207/5303 & SAND 16XT, 32"	P. 79

Shown on Pro R 4-Seat.
*Aluminum roof comes stock on Premium/Ultimate models.

Take on unpredictable landscapes and climb to new heights for epic views.

2884350	FULL VENTED WINDSHIELD - GLASS, 2-SEAT	P. 19
2884352	LOCK & RIDE POLY REAR PANEL, 2-SEAT	P. 19
2884237-458	ALUMINUM ROOF, 2-SEAT*	P. 20
2884658	FRONT DOOR INNER CLOSEOFF PANELS, 2-SEAT	P. 21
2884353-458	FRONT HIGH COVERAGE BUMPER	P. 22
2884356-458	REAR HIGH COVERAGE BUMPER	P. 22
2884685	FULL COVERAGE FENDER FLARES	P. 22
2883763	PREMIUM CONVEX REARVIEW MIRROR	P. 28
2883762	ADJUSTABLE FOLDING SIDE MIRRORS	P. 28
2883964	PMX-2 HEAD UNIT BY ROCKFORD FOSGATE®	P. 16
2883943	STAGE 2 AUDIO KIT BY ROCKFORD FOSGATE®	P. 16
2883857	STAGE 3 AUDIO UPGRADE BY ROCKFORD FOSGATE®	P. 16
2882074	PRO ARMOR 30" DUAL-ROW LED LIGHT BAR	P. 59
2889130	POLARIS PULSE HD LIGHT BAR HARNESS	P. 59
2412616	ADAPTER HARNESS	P. 59
2884235	LOCK & RIDE 57L FORWARD CARGO BOX	P. 26
2884286	9L SHOULDER STORAGE BAG	P. 27
2884341	POLARIS PRO HD 6,000 LB WINCH	P. 29
2885014	PRO ARMOR WHEEL & TIRE SET: 5206 & CRAWLER XR, 33"	P. 79

Shown on Pro R 2-Seat.
*Aluminum roof comes stock on Premium/Ultimate models.

TURBO R

INTRODUCING THE NEW

POLARIS RZR TURBO R



POWER | STRENGTH | CONTROL



> SUPERIOR INNOVATION

Seamlessly integrated technology offerings that take your ride to the next level.

ROCKFORD FOSGATE® AUDIO P.16
RIGID® LIGHTING P.24
POLARIS PULSE P.25
INTEGRATED WINCH P.29



PLUG & PLAY ELECTRICAL

EFFORTLESSLY ADD LIGHTS, AUDIO & WINCH



> ENDLESS CUSTOMIZATION

A complete accessory lineup developed to fit the needs of every riding style.

STORAGE P.26
COOLERS P.27
PRO ARMOR WHEELS & TIRES P.64



> UNRELENTING TOUGHNESS

Expertly engineered products that are sure to stand up to the elements.

WINDSHIELDS P.19
ROOFS P.20
PROTECTION P.22

PRO R, TURBO R & PRO XP

AUDIO

WINDSHIELDS & REAR PANELS

ROOFS, DOORS & HEATER

VEHICLE PROTECTION

LIGHTING

STORAGE

MISC, MIRRORS & WINCHES

> COLLECTIONS



> DESERT



> DUNE



> RUGGED TRAIL

Dominate rocky environments and charge through endless miles of hard-pack terrain.

2889019	FULL VENTED WINDSHIELD - GLASS	P. 19
2889750	GLASS WINDSHIELD WIPER KIT	P. 19
2883990-458	ALUMINUM ROOF, 4-SEAT*	P. 20
2884355-458	FRONT PRE RUNNER WINCH BUMPER	P. 23
2884585-458	REAR PRE RUNNER BUMPER	P. 23
2889209-458	HD EXTREME KICK-OUT ROCK SLIDERS, 4-SEAT	P. 23
2883763	PREMIUM CONVEX REARVIEW MIRROR	P. 28
2883762	ADJUSTABLE FOLDING SIDE MIRRORS	P. 28
2889463	STAGE 5 AUDIO UPGRADE BY ROCKFORD FOSGATE*	P. 16
2884648	RIGID® SR-SERIES 32" COMBO LED LIGHT BAR	P. 24
2884650	32" LIGHT BAR MOUNT	P. 24
2889130	POLARIS PULSE HD LIGHT BAR HARNESS	P. 24
2884359	RIGID® CHASE LIGHT	P. 25
2884896	CHASE LIGHT MOUNT KIT	P. 25
2889034	CHASE LIGHT HARNESS KIT	P. 25
2883751	LOCK & RIDE 70L FORWARD CARGO BOX	P. 26
2889740	LOCK & RIDE 22L REAR COOLER	P. 27
2884666	LOCK & RIDE 72L MULTI-PASSENGER REAR SEAT CARGO BOX	P. 27
2884304	7L DOOR STORAGE BAG	P. 27
2889404-458	PIVOTING SPARE TIRE CARRIER	P. 27
2884341	POLARIS PRO HD 6,000 LB WINCH	P. 29
2885008	PRO ARMOR WHEEL & TIRE SET: 5302 & CRAWLER XR, 33"	P. 79
5417174	PRO ARMOR SPARE TIRE: CRAWLER XR, 33"	P. 70
1524038	PRO ARMOR SPARE WHEEL: 5302, 15"	P. 76

Shown on Turbo R 4-Seat.
*Aluminum roof comes stock on Premium/Ultimate models.

Carve through the soft sands and tackle each hill with confidence.

2884746	LOCK & RIDE HALF WINDSHIELD - HARD COAT POLY, LOW	P. 19
2883991-458	LIGHT POCKET ALUMINUM ROOF, 4-SEAT	P. 20
2884660-458	ALUMINUM DOORS, 4-SEAT	P. 21
2884354-293	FRONT PRE RUNNER BUMPER	P. 23
2884646-293	ASSAULT GRILL	P. 28
2883763	PREMIUM CONVEX REARVIEW MIRROR	P. 28
2884624-293	ASSAULT BOMBER MIRRORS	P. 28
2883964	PMX-2 HEAD UNIT BY ROCKFORD FOSGATE*	P. 16
2883943	STAGE 2 AUDIO KIT BY ROCKFORD FOSGATE*	P. 16
2884655	STAGE 4 AUDIO UPGRADE BY ROCKFORD FOSGATE*	P. 16
2883945	REAR SPEAKER PODS BY ROCKFORD FOSGATE*	P. 16
2884074	RIGID® SR-SERIES 28" COMBO LED LIGHT BAR	P. 24
2889130	POLARIS PULSE HD LIGHT BAR HARNESS	P. 24
2884359	RIGID® CHASE LIGHT	P. 25
2884896	CHASE LIGHT MOUNT KIT	P. 25
2889034	CHASE LIGHT HARNESS KIT	P. 25
2884346	ACCENT LIGHT	P. 25
2883752	LOCK & RIDE 40L REAR CARGO BOX	P. 26
2883424	POLARIS NORTHSTAR 28L COOLER	P. 27
2884070	LOCK & RIDE NORTHSTAR 28L COOLER BRACKET	P. 27
2884304	7L DOOR STORAGE BAG	P. 27
2885020	PRO ARMOR WHEEL & TIRE SET: 5207/5303 & SAND 16XT, 32"	P. 79

Shown on Turbo R 4-Seat.

Take on unpredictable landscapes and climb to new heights for epic views.

2884305	LOCK & RIDE FULL VENTED WINDSHIELD - HARD COAT POLY	P. 19
2883757	LOCK & RIDE POLY REAR PANEL, 2-SEAT	P. 19
2883743-458	ALUMINUM ROOF, 2-SEAT*	P. 20
2884353-458	FRONT HIGH COVERAGE BUMPER	P. 22
2884189-458	REAR HIGH COVERAGE BUMPER	P. 22
2889208-458	HD EXTREME KICK-OUT ROCK SLIDERS, 2-SEAT	P. 23
2883763	PREMIUM CONVEX REARVIEW MIRROR	P. 28
2883762	ADJUSTABLE FOLDING SIDE MIRRORS	P. 28
2884655	STAGE 4 AUDIO UPGRADE BY ROCKFORD FOSGATE*	P. 16
2882077	PRO ARMOR 33" COMBO LED LIGHT BAR	P. 59
2889130	POLARIS PULSE HD LIGHT BAR HARNESS	P. 59
2412616	ADAPTER HARNESS	P. 59
2883751	LOCK & RIDE 70L FORWARD CARGO BOX	P. 26
2883752	LOCK & RIDE 40L REAR CARGO BOX	P. 26
2884286	9.5L SHOULDER STORAGE BAG	P. 27
2884304	7L DOOR STORAGE BAG	P. 27
2889404-458	PIVOTING SPARE TIRE CARRIER	P. 27
2884340	POLARIS PRO HD 4,500 LB WINCH	P. 29
2885018	PRO ARMOR WHEEL & TIRE SET: 5206 & PRO RUNNER, 33"	P. 78
5417533	PRO ARMOR SPARE TIRE: PRO RUNNER, 33"	P. 69
1524041	PRO ARMOR SPARE WHEEL: 5206, 15"	P. 76

Shown on Turbo R 2-Seat.
*Aluminum roof comes stock on Premium/Ultimate models.

POLARIS RZR PRO XP

CONQUER ANY TERRAIN

RIGID CHASE LIGHT
SEE P.25



> UNMATCHED ENGINEERING

Next-level innovation makes this RZR unlike anything you've ever owned.

ROCKFORD FOSGATE AUDIO P.16
RIDE COMMAND P.16
RIGID LIGHTING P.24
POLARIS PULSE P.24
INTEGRATED WINCH P.29



PLUG & PLAY ELECTRICAL

EFFORTLESSLY ADD
LIGHTS, AUDIO & WINCH



> VISIONARY DESIGN

Relentless attention to detail delivers extraordinary style and function for the ultimate ride.

WINDSHIELDS P.19
ROOFS P.20
DOORS P.21
MIRRORS P.28



> ELEVATED FUNCTIONALITY

An unrivaled selection of accessories gives you even more reason to get out – and stay out – riding.

PROTECTION P.22
STORAGE P.26
PRO ARMOR WHEELS & TIRES P.64

> COLLECTIONS



Dominate the rocky landscape and charge through endless miles of desert.

2889019	FULL VENTED WINDSHIELD - GLASS	P. 19
2889750	GLASS WINDSHIELD WIPER KIT	P. 19
2883743-458	ALUMINUM ROOF, 4-SEAT	P. 20
2883749-458	FRONT HIGH COVERAGE BUMPER	P. 22
2884189-458	REAR HIGH COVERAGE BUMPER	P. 22
2884359	RIGID CHASE LIGHT	P. 25
2884896	CHASE LIGHT MOUNT KIT	P. 25
2889034	CHASE LIGHT HARNESS	P. 25
2883751	70L FORWARD CARGO BOX	P. 26
2889740	LOCK & RIDE 22L REAR COOLER	P. 27
2884666	LOCK & RIDE 72L MULTI-PASSENGER REAR SEAT CARGO BOX	P. 27
2889404-458	PIVOTING SPARE TIRE CARRIER	P. 27

Shown on Pro XP 4-Seat.



Navigate the trails and soak up the old-growth groves, forests, plains and waterways.

2883756	LOCK & RIDE FULL VENTED WINDSHIELD - HARD COAT POLY	P. 19
2883928	POLY SPORT ROOF, 2-SEAT	P. 20
2883765	DOOR CLOSEOFFS*	P. 21
2883749-458	FRONT HIGH COVERAGE BUMPER	P. 22
2884189-458	REAR HIGH COVERAGE BUMPER	P. 22
2889208-458	HD EXTREME KICK-OUT ROCK SLIDERS, 2-SEAT	P. 23
2883751	70L FORWARD CARGO BOX	P. 26
2883752	40L REAR CARGO BOX	P. 26
2884304	7.25L DOOR STORAGE BAG	P. 27
2889404-458	PIVOTING SPARE TIRE CARRIER	P. 27
2883758	POLARIS PRO HD 4,500 LB WINCH	P. 29

Shown on Pro XP 2-Seat.

*Door Closeoffs come stock on Premium/Ultimate models



Climb pristine mountain trails for an epic view.

2883756	LOCK & RIDE FULL VENTED WINDSHIELD - HARD COAT POLY	P. 19
2883928	POLY SPORT ROOF, 2-SEAT	P. 20
2883749-458	FRONT HIGH COVERAGE BUMPER	P. 22
2884189-458	REAR HIGH COVERAGE BUMPER	P. 22
2889208-458	HD EXTREME KICK-OUT ROCK SLIDERS, 2-SEAT	P. 23
2883752	40L REAR CARGO BOX	P. 26
2884304	7.25L DOOR STORAGE BAG	P. 27
2889404-458	PIVOTING SPARE TIRE CARRIER	P. 27
2883758	POLARIS PRO HD 4,500 LB WINCH	P. 29

Shown on Pro XP 2-Seat.



Take advantage of any season with year-round riding.

2889536	TIP OUT WINDSHIELD - HARD COAT POLY	P. 19
2883757	LOCK & RIDE POLY REAR PANEL, 2-SEAT	P. 19
2883743-458	ALUMINUM ROOF, 2-SEAT	P. 20
2884664	CANVAS UPPER HALF DOORS, 2-SEAT	P. 21
2884658	FRONT DOOR INNER CLOSEOFF PANELS	P. 21
2883749-458	FRONT HIGH COVERAGE BUMPER	P. 22
2884189-458	REAR HIGH COVERAGE BUMPER	P. 22
2884685	FULL COVERAGE FENDER FLARES	P. 22
2884386	HEATER KIT	P. 21

Shown on Pro XP 2-Seat.

< ALL-SEASON

PRO R, TURBO R & PRO XP

A NEW AUDIO EXPERIENCE



Rockford Fosgate partnered with Polaris to create the next evolution of factory-installed off-road audio. Purpose-built to stand up to any outdoor environment and designed to perform no matter the ride. Specifically tuned and rider-centric to create an audio experience that is second to none.

- PLUG & PLAY
- ELEMENT READY
- NO LOSS OF CARGO SPACE
- BLUETOOTH

SOURCE UNITS

- Designed specifically for the Pro XP platform
- Tuned to combat wind and motor noise, delivering an incredible sound no matter the speed
- Element ready design guards against dust and moisture intrusion

AMPLIFIERS

- Ultra Compact CLEAN technology
- Highly efficient design capable of being pushed hard without overheating

SPEAKERS

- Off-Road Optimized Element Ready speakers that thrive in any outdoor environment
- Specifically tuned enclosures create rich cockpit sound
- Rugged, yet lightweight, materials that don't sacrifice speed for sound

SUBWOOFERS

- High-power, high-excursion subwoofer that acoustically couples with the cockpit for perfect bass response
- Torture tested to ensure long life and performance

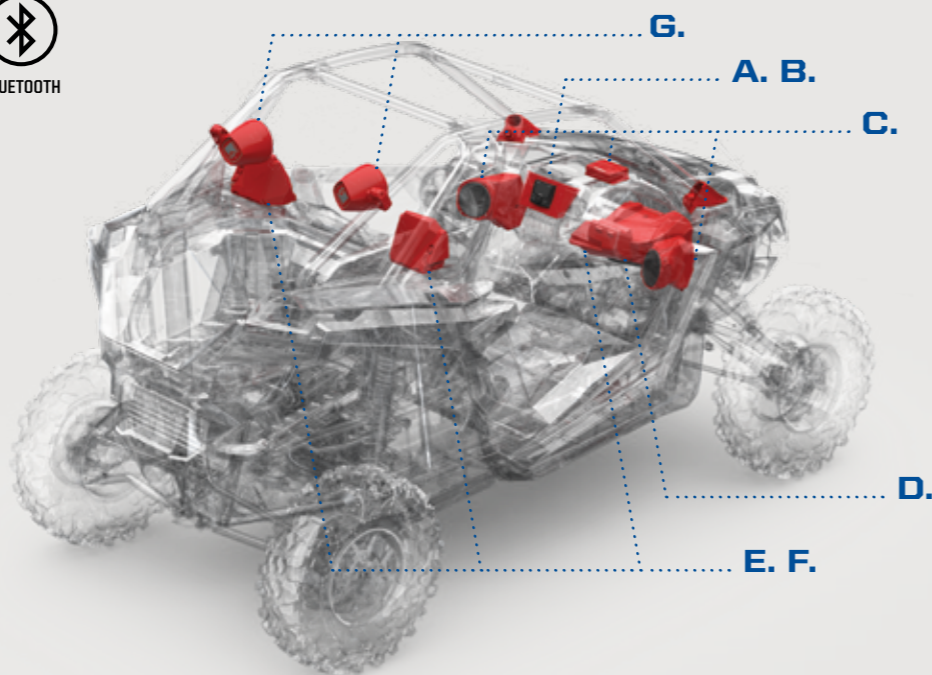

A. 7" DISPLAY POWERED BY RIDE COMMAND

2884072

PRO R 4 '22, PRO R '22, TURBO R 4 '22, TURBO R '22, PRO XP 4 '20-22, PRO XP '20-22

REQUIRES MOUNT KIT 2884584

STANDARD ON PREMIUM/ULTIMATE MODELS

SEE P. 60 FOR FULL RIDE COMMAND DETAILS

B. PMX-2 HEAD UNIT

- 6.86 cm full color display
- AM/FM/WB tuner*
- Pandora control
- Bluetooth connectivity
- Includes mount kit

2883964

PRO R 4 '22, PRO R '22, TURBO R 4 '22, TURBO R '22, PRO XP 4 '20-22, PRO XP '20-22

NOT COMPATIBLE WITH PREMIUM/ULTIMATE MODELS

C. STAGE 2 FULL RANGE AMPLIFIER AND FRONT UNDER-DASH SPEAKERS

- 400 watt full range amplifier
- 50 watt 16.51 cm component speakers including tweeters with enclosures

2883943

PRO R 4 '22, PRO R '22, TURBO R 4 '22, TURBO R '22, PRO XP 4 '20-22, PRO XP '20-22

STANDARD ON PREMIUM/ULTIMATE MODELS

D. STAGE 3 25.4 cm POWERED SUBWOOFER UPGRADE

- 400 watt 25.4 cm subwoofer with enclosure and grille
- 400 watt integrated subwoofer amplifier

2883857

PRO R 4 '22, PRO R '22, TURBO R 4 '22, TURBO R '22, PRO XP 4 '20-22, PRO XP '20-22

E. STAGE 4 25.4 cm POWERED SUBWOOFER WITH REAR COAXIAL SPEAKER UPGRADE

- 400 watt 25.4 cm subwoofer with enclosure and grille
- 400 watt integrated subwoofer amplifier
- 50 watt 16.51 cm coaxial speakers with enclosures and grilles

2884655

PRO R 4 '22, PRO R '22, TURBO R 4 '22, TURBO R '22, PRO XP 4 '20-22, PRO XP '20-22

F. STAGE 5 30 cm POWERED SUBWOOFER WITH FULL SYSTEM SPEAKER UPGRADE

- 400 watt 30 cm subwoofer with enclosure and grille
- 400 watt integrated subwoofer amplifier
- 100 watt 16.51 cm coaxial speakers with enclosures and stainless steel grilles
- 100 watt 16.51 cm front component replacement speakers
- High output tweeters with stainless steel grilles
- 2x more power and sound delivery over the stock system

2889463

PRO R 4 '22, PRO R '22, TURBO R 4 '22, TURBO R '22, PRO XP 4 '20-22, PRO XP '20-22

COMPATIBLE WITH PREMIUM/ULTIMATE ONLY

NOT COMPATIBLE WITH REAR PODS (2883945)

SUBWOOFER ADDITION ELIMINATES GLOVE BOX STORAGE

*20-21 PRO XP REQUIRES REAR AUDIO HARNESS (2415152), SOLD SEPARATELY

G. REAR PODS USE WITH STAGE 2, STAGE 3 OR STAGE 4

- 50 watt 16.51 cm coaxial speakers with can-enclosures, mounting hardware and grilles

2883945

PRO R 4 '22, PRO R '22, TURBO R 4 '22, TURBO R '22, PRO XP 4 '20-22, PRO XP '20-22

NOT COMPATIBLE WITH ROCKFORD FOSGATE ULTIMATE LE MODELS, STAGE 5 AUDIO UPGRADE (2889463)

> AUDIO

BUILD YOUR SOUND

(CHOOSE THE PATH THAT MATCHES YOUR RZR)

FACTORY-INSTALLED

SKIP TO STEP 3

PRO XP SPORT LE

2-SEAT PMX-P2 + STAGE 1

4-SEAT PMX-P2 + STAGE 1 AND REAR SPEAKERS

PRO R, TURBO R & PRO XP PREMIUM & ULTIMATE

2-SEAT RIDE COMMAND + STAGE 2

4-SEAT RIDE COMMAND + STAGE 2 AND REAR SPEAKERS

NO FACTORY AUDIO

STEP 1 SELECT HEAD UNIT

PMX-2 HEAD UNIT

2883964

PRO R 4 '22, PRO R '22, TURBO R 4 '22, TURBO R '22, PRO XP 4 '20-22, PRO XP '20-22

NOT COMPATIBLE WITH PREMIUM/ULTIMATE MODELS

MOUNT KIT INCLUDED

7" DISPLAY WITH RIDE COMMAND

2884072

PRO R 4 '22, PRO R '22, TURBO R 4 '22, TURBO R '22, PRO XP 4 '20-22, PRO XP '20-22

MOUNT KIT REQUIRED

2884584

PRO R 4 '22, PRO R '22, TURBO R 4 '22, TURBO R '22, PRO XP 4 '20-22, PRO XP '20-22

SEE P. 60 FOR FULL RIDE COMMAND DETAILS

STEP 2 ADD AUDIO KIT

STAGE 2 FULL RANGE AMPLIFIER AND FRONT UNDER-DASH SPEAKERS

2883943

PRO R 4 '22, PRO R '22, TURBO R 4 '22, TURBO R '22, PRO XP 4 '20-22, PRO XP '20-22

STANDARD ON PREMIUM/ULTIMATE MODELS

STEP 3 UPGRADE AUDIO

PRO XP SPORT LE ONLY AMP UPGRADE KIT

2884908

PRO XP 4 SPORT LE '21, PRO XP SPORT LE '21

REQUIRED FOR ANY SPORT LE TO UPGRADE TO STAGE 3 OR STAGE 4

STEP 3 UPGRADE AUDIO

STAGE 3 25.4 cm POWERED SUBWOOFER UPGRADE

2883857

PRO R 4 '22, PRO R '22, TURBO R 4 '22, TURBO R '22, PRO XP 4 '20-22, PRO XP '20-22

NOT COMPATIBLE WITH STAGE 4

STAGE 4 25.4 cm POWERED SUBWOOFER WITH REAR COAXIAL SPEAKER UPGRADE

2884655

PRO R 4 '22, PRO R '22, TURBO R 4 '22, TURBO R '22, PRO XP 4 '20-22, PRO XP '20-22

NOT COMPATIBLE WITH STAGE 3

ALL 4-SEAT MODELS WITH FACTORY AUDIO INCLUDE REAR SPEAKERS

OR

PRO R, TURBO R & PRO XP PREMIUM & ULTIMATE

STAGE 5 30 cm POWERED SUBWOOFER WITH FULL SYSTEM SPEAKER UPGRADE

2889463

PRO R 4 '22, PRO R '22, TURBO R 4 '22, TURBO R '22, PRO XP 4 '20-22, PRO XP '20-22

PREMIUM/ULTIMATE MODELS ONLY

PRO XP '20-21 REQUIRES REAR AUDIO HARNESS (2415152), SOLD SEPARATELY

NOT COMPATIBLE WITH REAR PODS (2883945), STAGE 3 OR STAGE 4

REAR PODS

2883945

PRO R 4 '22, PRO R '22, TURBO R 4 '22, TURBO R '22, PRO XP 4 '20-22, PRO XP '20-22

NOT COMPATIBLE WITH ROCKFORD FOSGATE ULTIMATE LE MODELS, STAGE 5 AUDIO UPGRADE (2889463)

ADD TO STAGES 1-4

REAR SPEAKER POD AUDIO HARNESS

2415152

PRO XP 4 '20-21, PRO XP '20-21

AUDIO HARNESS NOT REQUIRED ON PRO XP 4 MODELS WITH FACTORY INSTALLED REAR SPEAKERS

AUDIO HARNESS STANDARD ON 2022 MODELS

REQUIRED FOR STAGES 1-3

PRO R, TURBO R & PRO XP

AUDIO

WINDSHIELDS & REAR PANELS

ROOFS, DOORS & HEATER

VEHICLE PROTECTION

LIGHTING

STORAGE

MISC. MIRRORS & WINCHES

> BUILD YOUR CAB

ADD COMFORT AND STYLE WITH END-TO-END PROTECTION

ADD A ROOF
Shield from harsh elements while adding style.

ADD A REAR PANEL
Maintain rear visibility while reducing rear air swirl.

ADD A WINDSHIELD
Protect all riders with optical clarity.

ADD DOORS
Keep the cab free of debris and water.



LOCK & RIDE

REVOLUTIONARY INSTALLATION

Lock & Ride clamps make for easy on-off and eliminate the risk of cracking.

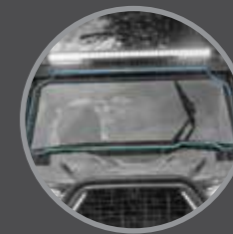

GASKETED SEAL

Keeps drafts and moisture out. Reduces ride chatter on full glass windshields.

WINDSHIELDS
GLASS



FULL VENTED WINDSHIELD - GLASS TOP SELLER

• Double-layer, laminated and tempered glass windshield with steel, powder-coated frame and adjustable center vent

» **TURBO R** **PRO XP** 2889019

TURBO R 4 '22, TURBO R '22, PRO XP 4 '20-22, PRO XP '20-22
NOT COMPATIBLE WITH LIGHT POCKET ALUMINUM ROOF (2883961, 2883991)

» **NEW** **PRO R** 2-SEAT • 2884350

PRO R '22

» **NEW** **PRO R** 4-SEAT • 2884823

PRO R 4 '22



GLASS WINDSHIELD WIPER KIT

• Simple to control with a multi-speed, dash-mounted switch

• Includes a washer fluid reservoir*

» 2889750

PRO R 4 '22, PRO R '22, TURBO R 4 '22, TURBO R '22, PRO XP 4 '20-22, PRO XP '20-22

COMPATIBLE WITH GLASS WINDSHIELD ONLY

*WASHER FLUID RESERVOIR NOT COMPATIBLE WITH PRO R 4/PRO R

HARD COAT POLY



LOCK & RIDE

FULL VENTED WINDSHIELD - HARD COAT POLY

• Impact-resistant, long-lasting .64 cm durable hard coated polycarbonate

• Full protection with airflow vents that quickly open for cockpit ventilation

» **TURBO R** **PRO XP** 2884305

TURBO R 4 '22, TURBO R '22, PRO XP 4 '20-22, PRO XP '20-22
COMPATIBLE WITH ALUMINUM ROOF ONLY (2883961, 2883743, 2883991, 2883990)

» **TURBO R** **PRO XP** 2883756

TURBO R 4 '22, TURBO R '22, PRO XP 4 '20-22, PRO XP '20-22
COMPATIBLE WITH POLY SPORT ROOF ONLY (2883928, 2883946)

» **NEW** **PRO R** 2-SEAT • 2884968

PRO R '22

» **NEW** **PRO R** 4-SEAT • 2884747

PRO R 4 '22



LOCK & RIDE

HALF WINDSHIELD - HARD COAT POLY, MID

• Impact-resistant, long-lasting .64 cm durable hard coated polycarbonate

• Provides both protection and airflow into the cab

• 30.48 cm tall

» 2884966

PRO R 4 '22, PRO R '22, TURBO R 4 '22, TURBO R '22, PRO XP 4 '20-22, PRO XP '20-22



TIP OUT WINDSHIELD - HARD COAT POLY

• Hard coated polycarbonate panel windshield with closed, vented and fully open positions

• Dual-handled latches with gas support struts

» **TURBO R** **PRO XP** 2889536

TURBO R 4 '22, TURBO R '22, PRO XP 4 '20-22, PRO XP '20-22

NOT COMPATIBLE WITH LIGHT POCKET ALUMINUM ROOF (2883961, 2883991)



LOCK & RIDE

HALF WINDSHIELD - HARD COAT POLY, LOW

• Provides added protection from the elements, while allowing optimum airflow and visibility

• 12.7 cm tall

» 2884746

PRO R 4 '22, PRO R '22, TURBO R 4 '22, TURBO R '22, PRO XP 4 '20-22, PRO XP '20-22

REAR PANEL

LOCK & RIDE

POLY REAR PANEL

• Drape formed 3mm polycarbonate for lightweight, impact-resistant durability

• Maintains rear visibility and reduces rear air swirl from entering the cockpit

• If installed, Rear Audio Pods should project backwards

» **TURBO R** **PRO XP**

2-SEAT

2883757

TURBO R '22, PRO XP '20-22

4-SEAT NOT SHOWN

2884147

TURBO R 4 '22, PRO XP 4 '20-22

» **NEW** **PRO R**

2-SEAT NOT SHOWN

2884352

PRO R '22

4-SEAT NOT SHOWN

2884594

PRO R 4 '22

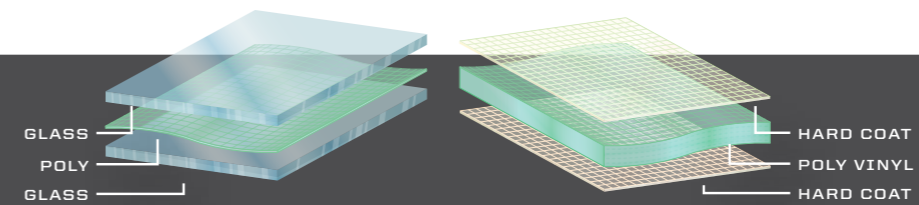

GLASS VS HARD COAT POLY

- Superior optical clarity (automotive level)
- Scratch-resistant
- Seals tight
- Cold weather/heavy duty

- Lightweight, flexible, easy to store/remove
- Impact-resistant
- 30x more scratch resistance than regular poly windshields

TURBO R **PRO XP**

RECOMMENDED 2-SEAT CAB

2889019	FULL VENTED WINDSHIELD - GLASS
2889750	GLASS WINDSHIELD WIPER KIT
2883757	POLY REAR PANEL
2883928	POLY SPORT ROOF
2884664	CANVAS UPPER HALF DOORS
2884658	FRONT DOOR INNER CLOSEOFF PANEL!

TURBO R **PRO XP**

RECOMMENDED 4-SEAT CAB

2884305	FULL VENTED WINDSHIELD - HARD COAT POLY
2884147	POLY REAR PANEL
2883990-458	ALUMINUM ROOF
2884660-458	ALUMINUM DOORS
2884665	CANVAS UPPER HALF DOORS

Available on 2-Seat and 4-Seat vehicles.

Available on 2-Seat and 4-Seat vehicles.

PRO R, TURBO R & PRO XP

AUDIO

WINDSHIELDS & REAR PANELS

ROOFS, DOORS & HEATER

VEHICLE PROTECTION

LIGHTING

STORAGE

MISC. MIRRORS & WINDCHIPS

> ROOFS

POLY

POLY SPORT ROOF

- Durable, lightweight polypropylene with contoured design for water run-off
- Maximum protection with full seal for a leak-free barrier and reduced chatter

TURBO R	PRO XP		
COLOR	2-SEAT	4-SEAT	NOT SHOWN
■ MATTE BLACK	2883928	2883946	
TURBO R '22, PRO XP '20-22		TURBO R 4 '22, PRO XP 4 '20-22	

ALUMINUM VS HARD COAT POLY

- | | |
|--|--|
| <ul style="list-style-type: none"> • High protection strength • Lower profile • Sleek style | <ul style="list-style-type: none"> • Water run-off • Pre-existing mounting features • Lightweight |
|--|--|



ALUMINUM

ALUMINUM ROOF

- .32 cm lightweight aluminum stamped sheet with full seal for a leak-free barrier and vibration elimination
- Quick install, low-profile design with maximum protection and durability from the harshest conditions

TURBO R	PRO XP		
COLOR	2-SEAT	4-SEAT	NOT SHOWN
■ MATTE BLACK	2883743-458	2883990-458	
■ INDY RED	2883743-293	2883990-293	
TURBO R '22, PRO XP '20-22		TURBO R 4 '22, PRO XP 4 '20-22	
MATTE BLACK STOCK ON TURBO R 4/TURBO R PREMIUM/ULTIMATE			

PRO R		
COLOR	2-SEAT	4-SEAT
■ MATTE BLACK	2884237-458	2884325-458
PRO R '22		PRO R 4 '22
STOCK ON PREMIUM/ULTIMATE		STOCK ON PREMIUM/ULTIMATE

LIGHT POCKET ALUMINUM ROOF

- .32 cm lightweight aluminum stamped sheet with full seal for a leak-free barrier and vibration elimination
- Low-profile with light pocket
- Quick installation with maximum protection and durability from the harshest conditions
- Not compatible with Full Vented Windshield - Glass (2889109) or Tip Out Windshield - Hard Coat Poly (2889536)

TURBO R	PRO XP		
COLOR	2-SEAT	4-SEAT	NOT SHOWN
■ MATTE BLACK	2883961-458	2883991-458	
TURBO R '22, PRO XP '20-22		TURBO R 4 '22, PRO XP 4 '20-22	

ADD THE 71.12 cm RIGID SINGLE ROW LED LIGHT BAR, WHICH FITS PERFECTLY INTO THE ROOF POCKET. SEE P. 24 FOR MORE DETAILS



VISIONARY DESIGN

Relentless attention to detail delivers extraordinary style and function for the ultimate ride.

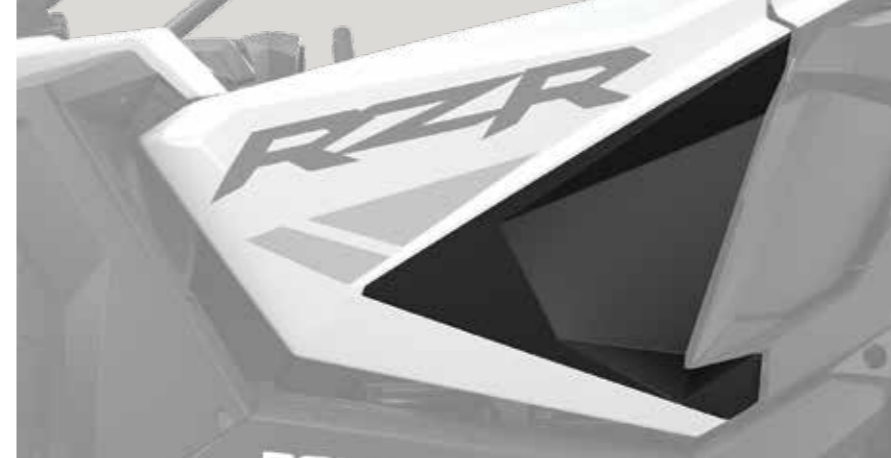

> DOORS

DOOR CLOSEOFFS

- Lightweight plastic door closeoffs provide riders protection from mud, rocks and water
- Quick installation and seamless fit into door opening
- Retains front ventilation

▶ 2883765
PRO R '22, TURBO R '22, PRO XP '20-22
STANDARD ON 4-SEAT, PREMIUM/ULTIMATE MODELS

ALUMINUM DOORS

- 12-gauge thick, stamped aluminum with full lower coverage and seal to keep out water, mud, dust and debris
- Uses factory door frames, with 4-Seat option providing an additional seal between front and rear doors
- Compatible with Front Door Inner Closeoff Panels (2884658, 2884831) and Canvas Upper Half Doors (2884664, 2884665)

COLOR	2-SEAT	NOT SHOWN	4-SEAT
■ MATTE BLACK	2884659-458		2884660-458
PRO R '22, TURBO R '22, PRO XP '20-22		PRO R 4 '22, TURBO R 4 '22, PRO XP 4 '20-22	
NOT COMPATIBLE WITH LOW PROFILE ROCK SLIDERS (2883987)			



FRONT DOOR INNER CLOSEOFF PANELS

- Vacuum formed polyethylene with full lower coverage and seal that keeps out water, mud, dust and debris
- Built-in armrest
- 2-Seat option maintains color accent boomerang
- Compatible with Door Closeoffs (2883765) and Aluminum Doors (2884659-458, 2884660-458)

▶ 2-SEAT • 2884658
PRO R '22, TURBO R '22, PRO XP '20-22
NOT COMPATIBLE WITH ROCK SLIDERS (2883760, 2883997)

▶ 4-SEAT • 2884831 NOT SHOWN
PRO R 4 '22, TURBO R 4 '22, PRO XP 4 '20-22
NOT COMPATIBLE WITH ROCK SLIDERS (2883987, 2883988)



CANVAS UPPER HALF DOORS

- High quality compression molded doors nest into thermoformed high-density polyethylene side shrouds for excellent sealing
- Includes zip-down 30-gauge clear vinyl windows
- Provides profiled cab edge for superior fit and finish
- Includes seals for key closeoff areas

▶ TURBO R PRO XP 2-SEAT • 2884664
TURBO R '22, PRO XP '20-22

▶ TURBO R PRO XP 4-SEAT • 2884665 NOT SHOWN
TURBO R 4 '22, PRO XP 4 '20-22

SOME DRIVERS MAY EXPERIENCE PASSENGER SIDE MIRROR OBSTRUCTION WHEN USED WITH UPPER HALF DOORS. USE WITH CAUTION.

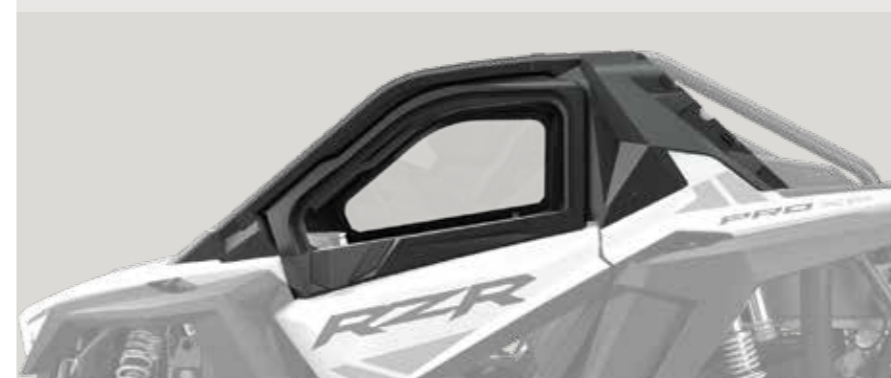

> HEATER

HEATER KIT

- Connects to Polaris PULSE bus bar to provide reliable, steady heat to your cab with fan speed and temperature control
- Closeable driver and passenger floor vents and electronic demist vent shutoff

▶ PRO XP 2884386
PRO XP 4 '20-22, PRO XP '20-22



CHOOSE YOUR DOOR

ADD DOOR ACCESSORIES

PRO R, TURBO R & PRO XP

AUDIO

WINDSHIELDS & REAR PANELS

ROOFS, DOORS & HEATER

VEHICLE PROTECTION

LIGHTING

STORAGE

MISC, MIRRORS & WINDCHIPS

> BUMPERS / FENDER FLARES

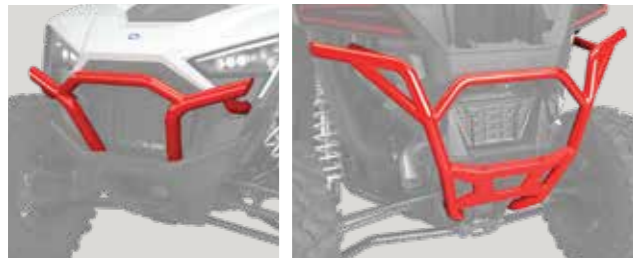

LOW PROFILE BUMPER

- Durable, powder-coated 3.8 cm - 4.5 cm tube steel with sleek lower profile

COLOR	PRO XP	
	FRONT	REAR
MATTE BLACK	2883746-458	2883748-458
INDY RED	2883746-293	2883748-293
BLUE METALLIC	2883746-751	2883748-751

PRO XP 4 '20-22, PRO XP '20-22
TURBO R 4 '22, TURBO R '22, PRO XP 4 '20-22, PRO XP '20-22

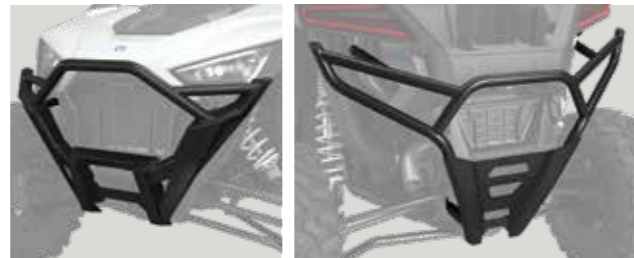

HIGH COVERAGE BUMPER

- Durable 12-gauge, powder-coated steel with extended high-coverage design for maximum vehicle protection

COLOR	PRO XP	
	FRONT	REAR
MATTE BLACK	2883749-458	2884189-458
INDY RED	2883749-293	2884189-293
ZENITH BLUE	2883749-849	2884189-849

PRO XP 4 '20-22, PRO XP '20-22
TURBO R 4 '22, TURBO R '22, PRO XP 4 '20-22, PRO XP '20-22



NEW HIGH COVERAGE BUMPER

- Durable 10-gauge, powder-coated 1.75" tube steel
- Compatible with winch or 6" light bar, both sold separately

COLOR	PRO R	TURBO R	PRO R
	FRONT		REAR
MATTE BLACK	2884353-458		2884356-458

PRO R 4 '22, PRO R '22, TURBO R 4 '22, TURBO R '22

PRO R 4 '22, PRO R '22



NEW PRE RUNNER BUMPER

- Durable, powder-coated 1.5" steel tube

COLOR	PRO R	TURBO R	PRO R
	FRONT		REAR
MATTE BLACK	2884354-458		2884358-458
INDY RED	2884354-293		2884358-293

PRO R 4 '22, PRO R '22, TURBO R 4 '22, TURBO R '22

PRO R 4 '22, PRO R '22

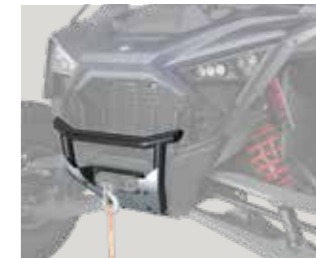

NEW PRE RUNNER WINCH BUMPER

- Durable, powder-coated 1.5" steel tube
- Requires winch (2884340, 2884341), sold separately

COLOR	PRO R	TURBO R
	FRONT	
MATTE BLACK	2884355-458	
INDY RED	2884355-293	

PRO R 4 '22, PRO R '22, TURBO R 4 '22, TURBO R '22



NEW PRE RUNNER BUMPER

- Durable, powder-coated 1.5" steel tube

COLOR	PRO XP	
	FRONT	REAR
MATTE BLACK	2884581-458	2884585-458

PRO XP 4 '20-22, PRO XP '20-22
TURBO R 4 '22, TURBO R '22, PRO XP 4 '20-22, PRO XP '20-22



INTEGRATED WINCH
SEE P. 29



RIGID 15.24 cm LIGHT BAR
SEE P. 24

Next-level style and function. Front bumpers are designed to effortlessly integrate a winch or 15.2 cm RIGID light bar.



FULL COVERAGE FENDER FLARES

- Covers the rear body opening to prevent mud from flying into the vehicle
- Maximum protection with 15.2 cm of additional coverage and extended, removable mud flaps
- Front and rear included

2884685

PRO R 4 '22, PRO R '22, TURBO R 4 '22, TURBO R '22, PRO XP 4 '20-22, PRO XP '20-22

> ROCK SLIDERS



10-GAUGE STAMPED STEEL
NO LOSS IN GROUND CLEARANCE

LOW PROFILE

COLOR	2-SEAT	4-SEAT
	MATTE BLACK	2883760-458
INDY RED	2883760-293	2883987-293

PRO R '22, TURBO R '22, PRO XP '20-22

PRO R 4 '22, TURBO R 4 '22, PRO XP 4 '20-22



4.5CM STEEL TUBE CONSTRUCTION WITH 70% THICKER WALLS, EXTENDS FROM MACHINE FOR MAX PROTECTION THROUGH ROUGH TERRAIN

HD EXTREME KICK-OUT

COLOR	2-SEAT	4-SEAT
	MATTE BLACK	2889208-458
INDY RED	2889208-293	2889209-293

PRO R '22, TURBO R '22, PRO XP '20-22

PRO R 4 '22, TURBO R 4 '22, PRO XP 4 '20-22

SEAMLESS INSTALLATION

Reusable anchors allow for easy installation of rock sliders into the built-in, dedicated chassis location.



CLOSED/UNLOCKED



OPEN/LOCKED

ALL ROCK SLIDERS: ONLY COMPATIBLE WITH ALUMINUM DOORS (2884660-458, 2884659-458) WHEN DOOR SEAL IS REMOVED. NOT COMPATIBLE WITH FRONT DOOR INNER CLOSEOFF PANELS (2884658, 2884831)

> LIGHTING



ADVANCED TECH

RIGID® lights are driven by Aluminum PCB Smart Boards™, 6063-T5 aircraft aluminum extruded housings and Tiger Drylac® UV protection polyester powdercoating.

EXCLUSIVE OPTICS

RIGID® invests heavily in optical science and has patented multiple optics and optics systems, maximizing light output and efficiency.

1. CHOOSE YOUR LIGHT BAR

LIGHT BAR OPTIONS

BRAND	RIGID	TURBO R / PRO XP	RIGID	RIGID
SIZE	15.2 cm	71.1 cm	71.1 cm	81.3 cm
TYPE	DUAL-ROW E-SERIES	SR-SERIES	SR-SERIES	SR-SERIES
RAW LUMENS	9,504	17,556	17,556	20,064
PN	2884649	2884074	2884074	2884648
FITMENT	PRO R 4 '22, PRO R '22, TURBO R 4 '22, TURBO R '22, PRO XP 4 '20-22, PRO XP '20-22	TURBO R 4 '22, TURBO R '22, PRO XP 4 '20-22, PRO XP '20-22	TURBO R 4 '22, TURBO R '22, PRO XP 4 '20-22, PRO XP '20-22	PRO R 4 '22, PRO R '22, TURBO R 4 '22, TURBO R '22, PRO XP 4 '20-22, PRO XP '20-22

MOUNTS IN WINCH POCKET FOR SEAMLESS INTEGRATION IN FRONT BUMPERS

DESIGNED FOR USE WITH LIGHT POCKET ALUMINUM ROOF

MOUNTS TO ROOF FOR MAXIMUM VISIBILITY



RIGID CHASE LIGHT

- Bright, daylight visible lighting with eleven selectable modes, including white scene lighting for accessing cargo bed in the dark
 - Connects into brake light system for additional high mount brake light
- » 2884359
PRO R 4 '22, PRO R '22, TURBO R 4 '22, TURBO R '22, PRO XP 4 '20-22, PRO XP '20-22



ACCENT LIGHT

- Durable construction resists dust and water while on the trails
 - Front fascia LED accent light
- » 2884346
PRO R 4 '22, PRO R '22, TURBO R 4 '22, TURBO R '22, PRO XP 4 '20-22, PRO XP '20-22
STANDARD ON PREMIUM/ULTIMATE MODELS

POLARIS ENGINEERED ADVANTAGES

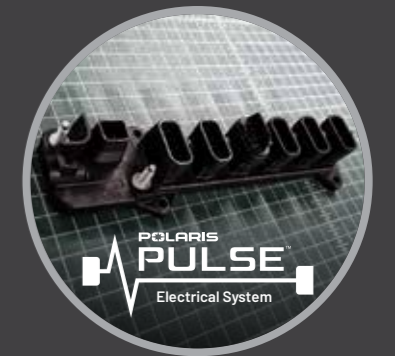

PLUG & PLAY ELECTRICAL

POLARIS PULSE IS A REVOLUTIONARY way to provide power to your vehicle and makes adding electrical accessories a snap.

2. ADD A MOUNT

MOUNT OPTIONS

15.2 cm LIGHT BAR MOUNT	71.1 cm LIGHT	81.3 cm LIGHT BAR MOUNT	CHASE LIGHT MOUNT KIT
<p>TURBO R / PRO XP</p> <p>» 2884654 TURBO R 4 '22, TURBO R '22, PRO XP 4 '20-22, PRO XP '20-22</p>	<p>NEW PRO R</p> <p>» 2884595 PRO R 4 '22, PRO R '22</p> <p>MOUNT INCLUDED WITH LIGHT</p>	<p>TURBO R / PRO XP</p> <p>» 2884650 TURBO R 4 '22, TURBO R '22, PRO XP 4 '20-22, PRO XP '20-22</p>	<p>NEW PRO R</p> <p>» 2884601 PRO R 4 '22, PRO R '22</p> <p>» 2884896 PRO R 4 '22, PRO R '22, TURBO R 4 '22, TURBO R '22, PRO XP 4 '20-22, PRO XP '20-22</p>

HARNESS OPTIONS

MODEL	LIGHT BAR SET-UPS		CHASE LIGHT
	1 LIGHT IN 1 LOCATION ON 1 SWITCH	2 LIGHTS IN 2 LOCATIONS ON 2 SWITCHES	
PRO R / 4 '22 TURBO R / 4 '22 PRO XP / 4 '20-22	<p>POLARIS PULSE LIGHT BAR HARNESS 2883949</p> <p>POLARIS PULSE HD LIGHT BAR HARNESS 2889130 FOR LIGHTS THAT DRAW OVER 10A</p>	<p>POLARIS PULSE LIGHT BAR HARNESS (x2) 2883949</p> <p>POLARIS PULSE HD LIGHT BAR HARNESS (x2) 2889130 FOR LIGHTS THAT DRAW OVER 10A</p>	<p>CHASE LIGHT HARNESS 2889034</p>



SEE FULL LIGHTING OPTIONS P.58



HAVE IT ALL

> STORAGE

	TURBO R	PRO XP	PRO R
28 L NORTHSTAR COOLER - GRAPHITE			2883424
LOCK & RIDE 28 L NORTHSTAR COOLER BRACKET	2884070		2889200
LOCK & RIDE REAR CARGO BOX	2883752		2884236
PIVOTING SPARE TIRE CARRIER	2889404-458		2884326-458
7.25 L DOOR STORAGE BAG			2884304
9.5 L SHOULDER STORAGE BAG			2884286

LOCK & RIDE

FORWARD CARGO BOX

TOP SELLER

- Protect your gear with lockable latches and side handles
- Durable polypropylene, engineered to seal out dust and water
- Lock & Ride strongly secures the box to the cargo bed

» **TURBO R** **PRO XP**

69 L • 2883751
TURBO R 4 '22, TURBO R '22, PRO XP 4 '20-22, PRO XP '20-22

» **NEW** **PRO R**

57 L • 2884235
PRO R 4 '22, PRO R '22



FIT:
2 Full-Size Helmets
Tool Kit
Jacket/Coat

LOCK & RIDE

REAR CARGO BOX

- Protect your gear with lockable latches and side handles
- Durable polypropylene, engineered to seal out dust and water
- Lock & Ride strongly secures the box to the cargo bed

» **TURBO R** **PRO XP**

40 L • 2883752
TURBO R 4 '22, TURBO R '22, PRO XP 4 '20-22, PRO XP '20-22

» **NEW** **PRO R**

34 L • 2884236
PRO R 4 '22, PRO R '22

FIT:
Sleeping Bag
First Aid Kit
Snacks
Sunscreen



LOCK & RIDE

72 L MULTI-PASSENGER REAR SEAT CARGO BOX

- Single wall base and dual wall lid that seal out dust and water
- Lock & Ride mounting for easy installation and removal
- Includes a drain plug and mounting hardware, with a location to add a padlock for increased security
- Only compatible with flip forward/fold flat storage in Premium/Ultimate models
- Fits full size off-road vehicle helmet

» 2884666

PRO R 4 '22, TURBO R 4 '22, PRO XP 4 '20-22



PIVOTING SPARE TIRE CARRIER

- Secure mounting with dual latches
- Steel mounts and rack
- Holds up to a 33" tire and supports 34 kg of weight
- Single-handed release mechanism

» **TURBO R** **PRO XP** 2889404-458

TURBO R 4 '22, TURBO R '22, PRO XP 4 '20-22, PRO XP '20-22

» **NEW** **PRO R** 2884326-458

PRO R 4 '22, PRO R '22

LOCK & RIDE

28 L REAR COOLER

- Lid locks securely in place with rubber latches to protect cargo
- Provides plenty of storage without weighing you down
- Keeps your food, beverages and bait fresh while out on the trails
- Nests with forward cargo box

» 2889740

PRO R 4 '22, PRO R '22, TURBO R 4 '22, TURBO R '22, PRO XP 4 '20-22, PRO XP '20-22



POLARIS NORTHSTAR 28 L COOLER

- Nests with rear cargo box

» GRAPHITE • 2883424

» DESERT • 2881315

PRO R 4 '22, PRO R '22, TURBO R 4 '22, TURBO R '22, PRO XP 4 '20-22, PRO XP '20-22

LOCK & RIDE

NORTHSTAR 28 L COOLER BRACKET

» **TURBO R** **PRO XP** 2884070

TURBO R 4 '22, TURBO R '22, PRO XP 4 '20-22, PRO XP '20-22

» **NEW** **PRO R** 2889200

PRO R 4 '22, PRO R '22

NOT COMPATIBLE WITH SPARE TIRE CARRIER

SEE P. 82 FOR FULL DETAILS ON POLARIS NORTHSTAR COOLERS



9.5 L SHOULDER STORAGE BAG

- Keeps your belongings safe and secure
- Molded sides, lid inserts, waterproof zipper and a nylon mesh pocket for versatile storage options
- Easy install and quick access with a sleek cockpit look

» 2884286

PRO R 4 '22, PRO R '22, TURBO R 4 '22, TURBO R '22, PRO XP 4 '20-22, PRO XP '20-22
FITS BETWEEN REAR SEATS ON 4-SEAT MODELS

FIT:
Flashlight
Snacks
Sunglasses
Bug Spray



7.25 L DOOR STORAGE BAG

- Quick reach access to keep supplies and gear secure
- Waterproof zipper keeps everything enclosed, clean and dry
- Molded face with EVA carbon fiber vinyl cover design

» 2884304

PRO R 4 '22, PRO R '22, TURBO R 4 '22, TURBO R '22, PRO XP 4 '20-22, PRO XP '20-22
COMPATIBLE WITH FRONT DOORS ONLY

NOT COMPATIBLE WITH FRONT DOOR INNER CLOSEOFF PANELS (2884658, 2884831)

FIT:
Cell Phone
Gloves
Sunscreen



FORWARD CARGO AND REAR CARGO STORAGE BOXES NEST PERFECTLY TOGETHER

REAR CARGO STORAGE BOX AND 28 L NORTHSTAR COOLER NEST PERFECTLY TOGETHER





> MISC

ASSAULT GRILL

- Constructed from high quality aluminum for lasting quality
- Enhanced style with a sleek colored badge

INDY RED 2884646-293

PRO R 4 '22, PRO R '22,
TURBO R 4 '22, TURBO R '22,
PRO XP 4 '20-22, PRO XP '20-22



> MIRRORS

ASSAULT BOMBER MIRRORS

- Billet aluminum construction to endure even the toughest trail conditions
- Colored accent bezels enhance the vehicle style

INDY RED 2884624-293

PRO R 4 '22, PRO R '22,
TURBO R 4 '22, TURBO R '22,
PRO XP 4 '20-22, PRO XP '20-22



S&B PARTICLE SEPARATOR

- Separates over 94% of dust before it reaches the air filter
- Integrated hidden design in the fender to stay out of sight
- Variable fan based on engine speed to keep noise levels low

PRO XP 2884629

PRO XP 4 '20-22, PRO XP '20-22

ORDERABLE THROUGH LOCAL DEALER ONLY



ADJUSTABLE FOLDING SIDE MIRRORS

- Installs in minutes and integrates into a designated mounting position
- Laminated safety glass for excellent scratch resistance

2883762

PRO R 4 '22, PRO R '22,
TURBO R 4 '22, TURBO R '22,
PRO XP 4 '20-22, PRO XP '20-22



PREMIUM CONVEX REARVIEW MIRROR

TOP SELLER

- Installs in minutes and integrates into a designated mounting position
- Laminated safety glass for excellent scratch resistance

2883763

PRO R 4 '22, PRO R '22,
TURBO R 4 '22, TURBO R '22,
PRO XP 4 '20-22, PRO XP '20-22



> WINCHES



FEATURES	PRO PRO HEAVY DUTY SERIES		REPLACEMENT PARTS
RAPID ROPE RECOVERY	STANDARD		
AUTO STOP TECHNOLOGY	STANDARD		
WINCH LINE	SYNTHETIC ROPE		
CONTROL	WIRELESS & WIRED STANDARD		
MODEL	2,721 kg	2,041 kg	
PRO R / TURBO R PRO R 4 / PRO R '22 TURBO R 4 / TURBO R '22 INCLUDES BOTH WIRED AND WIRELESS REMOTE	NEW 2884341	NEW 2884340	
PRO XP 4 / PRO XP '20-22 INCLUDES BOTH WIRED AND WIRELESS REMOTE	2883759	2883758	

SEE ADDITIONAL WINCH INFORMATION P. 86



XP 1000

LOCK & RIDE HALF WINDSHIELD - HARD COAT POLY	P. 31
GRAPHIC SPORT ROOF	P. 32
FRONT & REAR BUMPERS	P. 32
LOW PROFILE ROCK SLIDERS	P. 32
MIRRORS	P. 35
RIGID LIGHTING	P. 58

> WINDSHIELDS

HARD COAT POLY



LOCK & RIDE
FULL VENTED WINDSHIELD - HARD COAT POLY

- Impact-resistant, long-lasting .64 cm durable hard coated polycarbonate
 - Full protection with airflow vents that quickly open for cockpit ventilation
- » 2884330
XP TURBO '19-21, XP 4 TURBO '19-21, XP 4 1000 '19-22, XP 1000 '19-22



LOCK & RIDE
HALF WINDSHIELD - HARD COAT POLY **TOP SELLER**

- Durable, optical-grade polycarbonate provides maximum impact resistance
- » 2884018
XP TURBO '19-21, XP 4 TURBO '19-21, XP 4 1000 '19-22, XP 1000 '19-22



LOCK & RIDE
HALF WINDSHIELD - HARD COAT POLY

- Impact-resistant, long-lasting .64 cm durable hard coated polycarbonate
 - Provides protection and airflow into the cab
 - 17.8 cm tall
- » 2884768
TURBO S '18-21, XP TURBO '19-21, TURBO S 4 '19-21, XP 4 TURBO '19-21, XP 4 1000 '19-22, XP 1000 '19-22

GLASS



LOCK & RIDE
FULL WINDSHIELD - GLASS

- Double layer laminated, tempered glass windshield
 - Fits seamlessly with the roof and hood of your vehicle to form a complete seal for maximum durability and reduced chatter
- » 2884331
XP TURBO '19-21, XP 4 TURBO '19-21, XP 4 1000 '19-22, XP 1000 '19-22

> REAR PANELS

ADD A REAR PANEL TO REDUCE THE DUST SWIRL



LOCK & RIDE
POLY REAR PANEL **TOP SELLER**

- » 2881614
XP TURBO '15-21, XP 4 TURBO '16-21, XP 4 1000 '14-22, XP 1000 '14-22
NOT COMPATIBLE WITH EXTREME AUDIO PODS (2883739)



LOCK & RIDE
MESH REAR PANEL

- » 2879507
XP TURBO '15-21, XP 4 TURBO '16-21, XP 4 1000 '14-22, XP 1000 '14-22



LOCK & RIDE
REAR RACE NET

- » 2879936
XP TURBO '15-21, XP 4 TURBO '16-21, XP 4 1000 '14-22, XP 1000 '14-22

> DOORS



LOCK & RIDE
ALUMINUM DOORS

- Single-piece stamped aluminum maximizes quality, fit and finish
 - More cockpit room with wide berth
 - Gasket design eliminates rattling and creates a firm seal
 - Graphics not included
- » 2-SEAT • 2879510 **NOT SHOWN**
TURBO S '18-21, XP TURBO '15-21, XP 1000 '14-22
- » 4-SEAT • 2879943
TURBO S 4 '19-21, XP 4 TURBO '16-21, XP 4 1000 '14-22



LOCK & RIDE
LOWER DOOR INSERTS **TOP SELLER**

- Covers the bottom of the door opening, shutting out water and dust
 - Durable plastic construction with steel frame
- » 2-SEAT • 2879509 **NOT SHOWN**
TURBO S '18-21, XP TURBO '15-21, XP 1000 '14-22
- » 4-SEAT • 2879942
TURBO S 4 '19-21, XP 4 TURBO '16-21, XP 4 1000 '14-22



LOCK & RIDE
CANVAS UPPER DOORS

- Easy install with stock door panels using pre-designated mounting points
 - 23 OZ mold-resistant, UV-stable and crack-resistant materials for lasting durability and protection
 - Install with roof, full windshield, rear panel and lower doors to create a full cab enclosure for colder weather and/or increased protection
 - Not compatible with Poly Sport Roof or Audio Roof options
- » 2-SEAT • 2884333
XP TURBO '19-21, XP 1000 '19-22
- » 4-SEAT • 2884332 **NOT SHOWN**
XP 4 TURBO '19-21, XP 4 1000 '19-22

> ROOFS

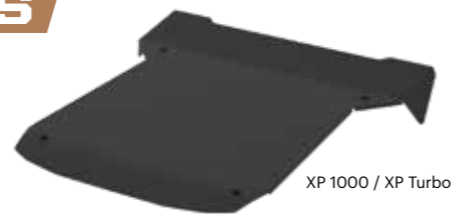
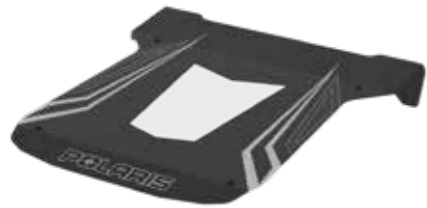

LOCK & RIDE

POLY SPORT ROOF TOP SELLER

- Rigid, injection-molded design to eliminate warping in high-heat conditions
- Integrated mounting locations for lighting
- Rugged, textured polyethylene construction for impact and abrasion resistance
- Not compatible with upper or full doors

COLOR	2-SEAT	4-SEAT <small>NOT SHOWN</small>
MATTE BLACK	2883073	2883074
	XP TURBO '15-21, XP 1000 '14-22	XP 4 TURBO '16-21, XP 4 1000 '14-22

GRAPHIC SPORT ROOF

- Weighs only 5 kg (30% lighter than aluminum)
- Won't bend or break upon impact with debris or other obstacles
- Sunroof lets in sunlight while keeping you shaded from the heat

COLOR	2-SEAT	4-SEAT <small>NOT SHOWN</small>
MATTE BLACK	2881206	2881935
INDY RED	2881607	2881936
	XP TURBO '15-21, XP 1000 '14-22	XP 4 TURBO '16-21, XP 4 1000 '14-22

ALUMINUM ROOF TOP SELLER

- Seals to the vehicle frame for the best protection and great integration with other RZR accessories
- Strong and durable 5051 aluminum construction for long-lasting, reliable protection

COLOR	2-SEAT	4-SEAT <small>NOT SHOWN</small>
MATTE BLACK	2881582-458	2881592-458
INDY RED	2881582-293	2881592-293
	XP TURBO '15-21, XP 1000 '14-22	XP 4 TURBO '16-21, XP 4 1000 '14-22
MATTE BLACK	2884086-458	2884087-458
	TURBO S '18-21	TURBO S 4 '19-21

COMES STOCK ON TURBO S AND TURBO S 4 DYNAMIX



> WINCHES



FEATURES	PRO PRO HEAVY DUTY SERIES	HD HEAVY DUTY SERIES	
RAPID ROPE RECOVERY	STANDARD	NOT AVAILABLE	
AUTO STOP TECHNOLOGY	STANDARD	OPTION	
WINCH LINE	SYNTHETIC ROPE	STEEL CABLE	
CONTROL	WIRELESS STANDARD, WIRED OPTION	WIRED STANDARD, WIRELESS OPTION	
MODEL	2,041 kg	1,588 kg	ADD REQUIRED CABLES
XP 4 1000 '14-22 XP 4 TURBO '16-21 XP 1000 '14-22 XP TURBO '15-21	<small>TOP SELLER</small> 2882240	<small>TOP SELLER</small> 2881671	XP 4 1000 / XP 1000 '19-22, XP 4 TURBO / XP TURBO '19-21 REQUIRE WINCH COVER KIT 2884118
TURBO S '18-21 TURBO S 4 '19-21	2883828		INCLUDED WITH WINCH
RS1 '18-22	2883825 <small>EXTREME BUMPER (2883783-458) REQUIRED, SOLD SEPARATELY</small>		INCLUDED WITH WINCH

See P. 59 for Bus Bar Harness fitment

SYNTHETIC ROPE	STEEL CABLE
2,041 kg SERIES » 2879187	1,588 kg SERIES » 2878890

WIRED REMOTE CONTROL		
• Must order remote handle and socket together		
» REMOTE HANDLE 4013466	» SOCKET 4017102	» SOCKET 4014228
<small>WORKS WITH 2882240, 2883825</small>	<small>WORKS WITH 2883825</small>	<small>WORKS WITH 2882240, 2883828</small>

WIRELESS REMOTE	AUTO STOP UPGRADE
• Up to 15 m range with LED indicator	• Billet aluminum
• Direct plug & play operation	• Replaces stock fairlead
» 2879316	» 2881693 <small>SYNTHETIC ROPE REQUIRED</small>

> BUMPERS & ROCK SLIDERS

LOW PROFILE BUMPER TOP SELLER

- Perfect for heavy-duty protection, with aggressive style and mounting for lights



COLOR	FRONT	REAR
MATTE BLACK	2884019-458	2884020-458
INDY RED	2884019-293	2884020-293
TITANIUM	2884019-632	2884020-632
SKY BLUE	2884019-737	2884020-737

XP TURBO '15-21, XP 4 TURBO '16-21, XP 4 1000 '14-22, XP 1000 '14-22

COLOR	FRONT	REAR
MATTE BLACK	2883132-458	2883133-458

TURBO S '18-21, TURBO S 4 '19-21

LOW PROFILE ROCK SLIDERS

- Plated steel construction, durable powdercoat finish
- Easy installation with expanded anchor mount

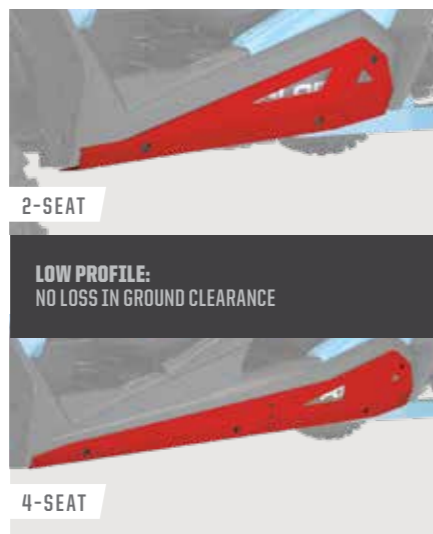

COLOR	2-SEAT	4-SEAT
MATTE BLACK	2879498-458	2879940-458
INDY RED	2881587-293	2881593-293
SKY BLUE	2881587-737	2881593-737

2-SEAT: TURBO S '18-21, XP TURBO '15-21, XP 1000 '14-22
4-SEAT: TURBO S 4 '19-21, XP 4 TURBO '16-21, XP 4 1000 '14-22

BUMPER ANCHOR PACK	
• Four anchors and two bumper end caps included	
» 2205114	

EXTREME KICK-OUT ROCK SLIDERS

- Rugged steel protection and race-inspired styling
- Low-profile mounting location will not diminish ground clearance



COLOR	2-SEAT	4-SEAT
MATTE BLACK	2879456-458	2882079-458
INDY RED	2881586-293	2882079-293
SKY BLUE	2881586-737	2882079-737

2-SEAT: TURBO S '18-21, XP TURBO '15-21, XP 1000 '14-22
4-SEAT: TURBO S 4 '19-21, XP 4 TURBO '16-21, XP 4 1000 '14-22

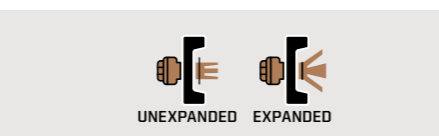

XP 1000, XP TURBO, TURBO S

WINDSHIELDS, REAR PANELS & DOORS

ROOF'S, VEHICLE PROTECTION & WINCHES

STORAGE & MIRRORS

RZR RS1 ACCESSORIES

> STORAGE



LOCK & RIDE 45 L COOLER BOX

- One-piece rotomolded construction for extreme durability
- Lid locks securely in place with rubber latches to protect cargo
- Heavy-duty hinges and weatherproof seal block moisture and dust
- Keeps food and beverages cool for 48+ hours, depending on conditions
- UV-fade resistant
- Installs quickly and easily without tools
- Easy to carry with integrated grab handles

» 2881555
TURBO S '18-21, XP TURBO '15-21, TURBO S 4 '19-21, XP 4 TURBO '16-21, XP 4 1000 '14-22, XP 1000 '14-22

LOCK & RIDE D-RINGS

» 2881544

BED D-RINGS

» 2877460
TURBO S '18-21, XP TURBO '15-21, TURBO S 4 '19-21, XP 4 TURBO '16-21, XP 4 1000 '14-22, XP 1000 '14-22

LOCK & RIDE EXPANSION ANCHOR

» 2876420



LOCK & RIDE 65 L CARGO BOX TOP SELLER

- Secure latching lid with taut rubber strap tie-downs
- Lightweight design integrates seamlessly into the rear cargo bed
- Includes all mounting hardware for complete installation

» 2881193
TURBO S '18-21, XP TURBO '15-21, TURBO S 4 '19-21, XP 4 TURBO '16-21, XP 4 1000 '14-22, XP 1000 '14-22



SPARE TIRE CARRIER

- Easily carry a spare tire without sacrificing valuable cargo box capacity
- Mounts to the rear cab frame extension in less than five minutes using four fasteners and an integrated, built-in lug wrench
- Remove two of the quick-release pins to pivot the carrier and gain access to the cargo box

» 2883487
TURBO S '18-21, TURBO S 4 '19-21

» 2879464
XP TURBO '15-21, XP 4 TURBO '16-21, XP 1000 '14-22, XP 4 1000 '14-22



LOWER DOOR STORAGE BAG

» 2880613
TURBO S '18-21, XP TURBO '16-21, TURBO S 4 '19-21, XP 4 TURBO '16-21, XP 4 1000 '14-22, XP 1000 '14-22
REQUIRES LOWER DOOR INSERTS (2879509, 2879942)
ONLY COMPATIBLE WITH FRONT DOORS

> MIRRORS



NEW ADJUSTABLE FOLDING SIDE MIRRORS

- Left and right mirrors included
- Installs in minutes and integrates into a designed mounting position
- Laminated safety glass for excellent scratch resistance

» 2884524
TRAIL S '21-22, TRAIL '21-22, TURBO S '18-21, XP TURBO '19-21, XP 1000 '14-22, TURBO S 4 '20-21, XP 4 TURBO '19-21, XP 4 1000 '14-22, S 900 '15-20, S 4 1000 '19-20, S 1000 '16-20, 900 '14-20



CONVEX DESIGN DELIVERS WIDE REAR VIEW

REARVIEW MIRROR TOP SELLER

- Works with all roofs, soft tops and windshields

» 2877945
TURBO S '18-21, XP TURBO '15-21, TURBO S 4 '19-21, XP 4 TURBO '16-21, XP 4 1000 '14-22, XP 1000 '14-22



SCRATCH-RESISTANT GLASS MIRROR LENS

CONVEX REARVIEW MIRROR TOP SELLER

- Bolts into your choice of pre-designated mounting locations on the vehicle frame for easy install
- Convex design provides broad, expanded view of what's behind or alongside the vehicle

» 2881540
TURBO S '18-21, XP TURBO '15-21, TURBO S 4 '19-21, XP 4 TURBO '16-21, XP 4 1000 '14-22, XP 1000 '14-22



QUICK GLANCE, WIDE-ANGLE VIEWING FOR MAXIMUM VISIBILITY

WIDE-ANGLE REARVIEW MIRROR

- Stamped steel frame and backing plate with large 6.4 cm x 35.6 cm convex mirror
- Up to 10° of range to adjust for rider height or view preference
- Easy over-structure installation with stamped steel mounts

» 2881199
TURBO S '18-21, XP TURBO '15-21, TURBO S 4 '19-21, XP 4 TURBO '16-21, XP 4 1000 '14-22, XP 1000 '14-22

POLARIS RZR RS1

ALUMINUM ROOF

- Strong, durable 5051 aluminum construction
- 360-degree sealed to eliminate vibration

» 2882698-458 • BLACK
RS1 '18-22

RZR SUBZERO 4-PT HARNESS

- Exclusive, controlled deceleration technology
- Better vehicle control, less ride fatigue and reduced submarining
- CAPE and Polaris validated

» 2882709
RS1 '18-22

EXTREME DUTY BUMPER

- Front bumper required for winch installation
- Easy installation into factory mounts
- Fully e-coated and powder-coated for premium protection
- Includes all mounting hardware

» FRONT • 2883783-458 • BLACK
» REAR • 2882694-458 • BLACK
RS1 '18-22

SPORT SIDE TIRE CARRIER

- Mounts directly to Extreme Kick-Out Rock Sliders (2882738)

» 2882738
RS1 '18-22

EXTREME KICK-OUT ROCK SLIDERS

- Fully e-coated and powder-coated for premium protection
- Stock ground clearance is maintained
- Required for the Sport Side Tire Carrier (2882738)

» 2882695-458 • BLACK
RS1 '18-22

LIGHTING & HARNESSES

SEE P. 58

LOCK & RIDE

FULL WINDSHIELD - HARD COAT POLY

- Frameless design fully seals around cab frame
- Premium, optical-grade impact-resistant poly material

» 2882703
RS1 '18-22

LOCK & RIDE

HALF WINDSHIELD - POLY NOT SHOWN

» 2882704
RS1 '18-22

PRO ARMOR WHEEL & TIRE SETS

SEE P. 78

POLARIS PRO HD 2,041 KG WINCH

» 2883825
RS1 '18-22

See P. 86 for full winch details

POLARIS ENGINEERED ADVANTAGES

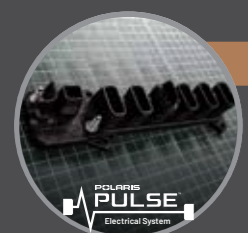

PLUG & PLAY ELECTRICAL

EFFORTLESSLY ADD LIGHTS

POLARIS PULSE LIGHT BAR HARNESS
2883388

SEE P. 59 FOR MORE INFORMATION



LOCK & RIDE

REVOLUTIONARY INSTALLATION

Lock & Ride clamps make for easy on-off and eliminate the risk of cracking.



49L

- 1 Helmet
- 2 Goggles/Gloves
- 12 Beverage Cans

LOCK & RIDE

49L REAR COOLER/STORAGE COMBO

- Seamless mounting to the rear cargo platform

» 2882701
RS1 '18-22



13L

- 10 Beverage Cans

13L UNDERHOOD COOLER/STORAGE COMBO

- Fits in the underhood compartment
- Removable, waterproof cooler liner for easy cleaning

» 2882700
RS1 '18-22



10L

- 1 Goggles
- 2 Cell Phones
- 3 Small Items

QUIKREACH 10L DOORPAK

- Three storage compartments
- "Quick to Reach" and mounted directly to driver-side door

» 2882697
RS1 '18-22



8L

- 2 Cell Phones
- 2 Gloves
- 1 Small Item

QUIKREACH 8L DASHPAKS

- "Quick to Reach" storage on both sides of steering wheel

» 2883332
RS1 '18-22



FRONT LOW PROFILE SPORT BUMPER

- Tough, tubular steel design
- Easy installation into factory mounts
- Fully e-coated and powder-coated for premium protection
- Includes all mounting hardware

» 2882692-458
RS1 '18-22



BLUETOOTH INTEGRATED 200 WATT AUDIO SYSTEM BY MB QUART

- 5.1 cm x 13.3 cm speakers and 1.9 cm titanium dome tweeters with dash enclosures
- Fully-integrated Bluetooth audio system
- Bluetooth remote fits seamlessly into switch panel
- Includes all necessary wiring, harnesses and mounting hardware

» 2882696
RS1 '18-22



FULL COVERAGE FENDER FLARES

- Extra-wide design protects you and your vehicle from kicked-up debris
- Easily and seamlessly attaches to existing plastic
- Front and rear included

» 2883488
RS1 '18-22



LOCK & RIDE

POLY REAR PANEL

» 2882706
RS1 '18-22

TRAILERABLE COVER NOT SHOWN

- Strong, durable, weatherproof canvas construction
- UV-stable to resist fading from prolonged exposure to sunlight

» 2882705
RS1 '18-22



ADD A REAR PANEL TO REDUCE THE DUST SWIRL

With a windshield and roof installed, turbulent air develops behind the cab. Add a rear panel to reduce dust intrusion from this swirl.

POLARIS
RZR TRAIL



TRAIL AGILITY.
ENDLESS COMFORT.



> **PERSONALIZED COMFORT**

All the essentials to customize your cab for comfortable riding in any element.

- WINDSHIELDS** P. 43
- ROOFS** P. 44
- DOORS** P. 44
- HEATER KIT** P. 48



> **PREMIUM TECHNOLOGY**

Take on the trails with unrivaled tech components, ranging from functional to fun.

- ROCKFORD FOSGATE AUDIO** P. 45
- POLARIS PULSE** P. 50
- LIGHTING** P. 50
- RIDE COMMAND** P. 60



PLUG & PLAY ELECTRICAL

EFFORTLESSLY ADD LIGHTS, AUDIO & WINCH



> **ULTIMATE DURABILITY**

Cover your bases with ease and protection, giving you confidence to stay riding longer.

- PROTECTION** P. 46
- STORAGE** P. 47
- PRO ARMOR WHEELS & TIRES** P. 64



EXPLORES



TRAILBLAZER



ADVENTURER

Feel confident to take on the trails with all the **essentials** you need.

2884773	TIP OUT WINDSHIELD - HARD COAT POLY	P. 43
2884729	LOCK & RIDE POLY SPORT ROOF	P. 44
2884732-458	FRONT HIGH COVERAGE BUMPER	P. 46
2884734-458	REAR BUMPER EXTENSION	P. 46
2883763	PREMIUM CONVEX REARVIEW MIRROR	P. 85
2884524	ADJUSTABLE FOLDING SIDE MIRRORS	P. 85
2884912	STAGE 1 PMX AUDIO KIT BY ROCKFORD FOSGATE	P. 45
2883945	REAR SPEAKER PODS BY ROCKFORD FOSGATE	P. 45
2415652	REAR SPEAKER POD AUDIO HARNESS	P. 45
2884871	FANG ACCENT LIGHTS*	P. 58
2883123	RIGID SR-SERIES 10" COMBO LED LIGHT	P. 59
2884657	LIGHT BAR HARNESS	P. 59
2884762	SPARE TIRE CARRIER	P. 47
2883216	PRO ARMOR WHEEL & TIRE SET: 4301 BEADLOCK & DUAL THREAT, 26" **	P. 78
5416340	PRO ARMOR SPARE TIRE: DUAL THREAT, 26" **	P. 69
1523283	PRO ARMOR SPARE WHEEL: 4301 BEADLOCK, 14"	P. 77

Shown on Trail.
*Fang accent lights come stock on Premium/Ultimate models (US models).
**May widen vehicle beyond 50".

Lead the charge with ultimate **protection** to enjoy the turns of the trails.

2884911	LOCK & RIDE FULL VENTED WINDSHIELD - HARD COAT POLY	P. 43
2884765	LOCK & RIDE POLY REAR PANEL	P. 43
2884761-458	ALUMINUM ROOF	P. 44
2884868-458	FRONT WINCH BUMPER	P. 46
2884734-458	REAR BUMPER EXTENSION	P. 46
2879456-458	EXTREME KICK-OUT ROCK SLIDERS	P. 46
2881985	FULL COVERAGE FENDER FLARES	P. 81
2883763	PREMIUM CONVEX REARVIEW MIRROR	P. 85
2884524	ADJUSTABLE FOLDING SIDE MIRRORS	P. 85
2881193	LOCK & RIDE 65 L CARGO BOX	P. 47
2885126	POLARIS PRO HD 4,500 LB WINCH WITH RAPID ROPE RECOVERY	P. 48
2883157	PRO ARMOR WHEEL & TIRE SET: 5202 & ATTACK 2.0, 28"	P. 78
2879332	12MM x 1.5 SPLINED LUG NUTS WITH WRENCH ADAPTER	P. 76

Shown on Trail S.

All-day riding made easy, with added **comfort** and maximum visibility.

2884756	FULL VENTED WINDSHIELD - GLASS	P. 43
2884755	WINDSHIELD WIPER - WASHER KIT	P. 43
2884765	LOCK & RIDE POLY REAR PANEL	P. 43
2884729	LOCK & RIDE POLY SPORT ROOF	P. 44
2884733	CANVAS UPPER DOORS, 60"	P. 44
2884019-293	FRONT LOW PROFILE BUMPER	P. 46
2881587-293	LOW PROFILE ROCK SLIDERS	P. 46
2883763	PREMIUM CONVEX REARVIEW MIRROR	P. 85
2884735	HEATER KIT	P. 48
2884917	FACTORY AUDIO STAGE 3 UPGRADE BY ROCKFORD FOSGATE	P. 45
2884648	RIGID SR-SERIES 81 CM COMBO LED LIGHT BAR	P. 50
2884650	81 CM LIGHT BAR MOUNT	P. 50
2884657	LIGHT BAR HARNESS	P. 50
2884183	POLARIS PULSE UNDERHOOD BUS BAR - 6 POSITION	P. 50
2881556	LOCK & RIDE 48 L COOLER BOX	P. 47
2885126	POLARIS PRO HD 4,500 LB WINCH WITH RAPID ROPE RECOVERY	P. 48
2883182	PRO ARMOR WHEEL & TIRE SET: 5203 BEADLOCK & CRAWLER X6, 28"	P. 79
1522240	15" FORGED BEADLOCK RING	P. 77
2879332	12MM x 1.5 SPLINED LUG NUTS WITH WRENCH ADAPTER	P. 76

Shown on Trail S.

> BUILD YOUR CAB

ADD COMFORT AND STYLE WITH END-TO-END PROTECTION

ADD A WINDSHIELD
Protect yourself and your passenger with optical clarity.

ADD A ROOF
Shield from harsh elements while adding style.

ADD A REAR PANEL
Maintain rear visibility while reducing rear air swirl.

ADD DOORS
Keep the cab free of debris and water.



LOCK & RIDE

REVOLUTIONARY INSTALLATION

Lock & Ride clamps make for easy on-off and eliminate the risk of cracking.



GASKETED SEAL

Keeps drafts and moisture out. Reduces ride chatter on full glass windshields.

WINDSHIELDS GLASS



WIPER READY

FULL VENTED WINDSHIELD - GLASS

- Double layer laminated, tempered glass windshield with steel powder-coated frame and center adjustable vent

» 2884756
TRAIL S '21-22, TRAIL '21-22



WINDSHIELD WIPER - WASHER KIT

- Simple to control, featuring a multi-speed dash-mounted rocker switch
- Includes a washer fluid reservoir

» 2884755
TRAIL S '21-22, TRAIL '21-22
COMPATIBLE WITH GLASS WINDSHIELD ONLY

HARD COAT POLY



LOCK & RIDE

FULL VENTED WINDSHIELD - HARD COAT POLY

- Impact-resistant, long-lasting .64 cm durable hard coated polycarbonate
- Full protection with airflow vents that quickly open for cockpit ventilation

» 2884811
TRAIL S '21-22, TRAIL '21-22



LOCK & RIDE

FULL WINDSHIELD - HARD COAT POLY

- Impact-resistant, long-lasting .64 cm durable hard coated polycarbonate
- No frame design offers maximum visibility
- Integrates with all cab components

» 2884757
TRAIL S '21-22, TRAIL '21-22



TIP OUT WINDSHIELD - HARD COAT POLY

- Hard coated polycarbonate panel windshield that offers three positions: closed, vented and full open
- Single-handed latch with gas support struts

» 2884773
TRAIL S '21-22, TRAIL '21-22



LOCK & RIDE

HALF WINDSHIELD - HARD COAT POLY

- Impact-resistant, long-lasting .64 cm durable hard coated polycarbonate
- Provides protection and airflow into the cab
- 17.8 cm tall

» 2884768
TRAIL S '21-22, TRAIL '21-22

RECOMMENDED BUILD 1

- 2884773 TIP OUT WINDSHIELD - HARD COAT POLY
- 2884765 LOCK & RIDE POLY REAR PANEL
- 2884761-458 ALUMINUM ROOF
- 2884733 CANVAS UPPER DOORS, 60" *

RECOMMENDED BUILD 2

- 2884756 FULL VENTED WINDSHIELD - GLASS
- 2884755 WINDSHIELD WIPER - WASHER KIT
- 2884765 LOCK & RIDE POLY REAR PANEL
- 2884729 LOCK & RIDE POLY SPORT ROOF
- 2884733 CANVAS UPPER DOORS, 60" *

*Trail models should use Canvas Upper Doors, 50" (2884758)

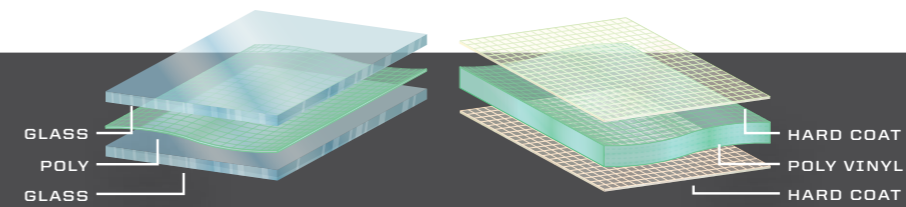

GLASS VS HARD COAT POLY

- Superior optical clarity (automotive level)
- Scratch-resistant
- Seals tight
- Cold weather/heavy duty
- Lightweight, flexible, easy to store/remove
- Impact-resistant
- 30x more scratch resistance than regular poly windshields

REAR PANEL

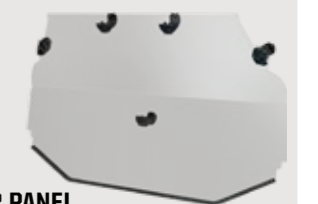

LOCK & RIDE

POLY REAR PANEL

- Maintains rear visibility and reduces rear air swirl from entering the cockpit
- Fully compatible with all accessories
- If installed, Rear Audio Pods should project backwards

» 2884765
TRAIL S '21-22, TRAIL '21-22

TRAIL



> ROOFS

ALUMINUM VS POLY

- High protection strength
- Lower profile
- Sleek style

- Water run-off channels
- Quick install
- Lightweight



ALUMINUM

ALUMINUM ROOF

- Seals to the roll cage for the best protection, while seamlessly integrating with other RZR accessories
- Strong and durable aluminum construction for long-lasting, reliable protection

COLOR	PART NUMBER
■ MATTE BLACK	2884761-458
■ INDY RED	2884761-293

TRAIL S '21-22, TRAIL '21-22

POLY

LOCK & RIDE POLY SPORT ROOF

- Rigid, injection-molded design to eliminate warping in high-heat conditions
- Integrated mounting locations for lighting
- Rugged, textured polyethylene construction for impact and abrasion resistance

COLOR	PART NUMBER
■ MATTE BLACK	2884729

TRAIL S '21-22, TRAIL '21-22
STANDARD ON ULTIMATE TRIM

> DOORS



CANVAS UPPER DOORS

- Pre-loaded tubular aluminum frame provides a tight seal along the roll cage
- Zip-down vinyl windows offer increased comfort in warmer conditions
- Zippered access ports for easy ingress and egress

- » 60" • 2884733
TRAIL S '21-22
- » 50" • 2884758 **NOT SHOWN**
TRAIL '21-22

ALUMINUM LOWER HALF DOORS

- Single-piece stamped aluminum maximizes quality, fit and finish
- Gasket design eliminates rattling and creates a firm seal

- » 2879510
TRAIL S '21-22

A NEW AUDIO

EXPERIENCE



Rockford Fosgate partnered with Polaris to create the next evolution of factory-installed off-road audio. Purpose built to stand up to any outdoor environment and designed to perform no matter the ride. Specifically tuned and rider-centric to create a class-leading audio experience that is second to none.

> AUDIO

BUILD YOUR SOUND (CHOOSE THE PATH THAT MATCHES YOUR RZR)

NO FACTORY AUDIO

STEP 1

SELECT HEAD UNIT & ADD AUDIO

7" DISPLAY POWERED BY RIDE COMMAND

2884072
TRAIL S '22

MOUNT KIT REQUIRED

2884731
TRAIL S '22

SEE P. 60 FOR FULL RIDE COMMAND DETAILS

OR

STAGE 1 PMX AUDIO KIT

2884912
TRAIL S '21-22, TRAIL '21-22

MOUNT KIT INCLUDED

STAGE 3 RIDE COMMAND AUDIO KIT

2884914
TRAIL S '22

STEP 2

UPGRADE AUDIO

REAR SPEAKER PODS

2883945

TRAIL S '21-22, TRAIL '21-22

REAR SPEAKER POD AUDIO HARNESS

2415652

TRAIL S '21-22, TRAIL '21-22

REQUIRED TO ADD PODS TO STAGE 1 OR STAGE 3



7" DISPLAY POWERED BY RIDE COMMAND

- » 2884072
TRAIL S '22
REQUIRES MOUNT KIT (2884731)
STANDARD ON ULTIMATE MODELS

SEE P. 60 FOR FULL RIDE COMMAND DETAILS



STAGE 1 PMX AUDIO KIT

- 6.86 cm full color display
- AM/FM/WB tuner w/ antenna
- Bluetooth connectivity
- Includes mount kit
- Two front 16.5 cm coaxial speakers with enclosures

- » 2884912
TRAIL S '21-22, TRAIL '21-22
NOT COMPATIBLE WITH ULTIMATE TRIM



STAGE 3 RIDE COMMAND AUDIO KIT FRONT SPEAKERS & SUBWOOFER

- 200 watt 25.4 cm subwoofer with enclosure
- 400 watt full range amplifier
- Two 50 watt 16.51 cm component speakers with enclosures

- » 2884914
TRAIL S '21-22, TRAIL '21-22
NOT COMPATIBLE WITH ULTIMATE TRIM OR STAGE 1 PMX AUDIO KIT



REAR SPEAKER PODS USE WITH STAGE 1 OR STAGE 3

- 50 watt 16.51 cm coaxial speakers with can-enclosures, mounting hardware and grilles
- Audio Harness (2415652) required, sold separately

- » 2883945
TRAIL S '21-22, TRAIL '21-22

* The FM Frequency range is from 88 to 108 and only on the odds (i.e. 88.1, 88.3, etc.).

> BUMPERS / FENDER FLARES



FRONT HIGH COVERAGE BUMPER

- Durable, powder-coated 4.45 cm tube steel with sleek profile for full coverage with headlight protection
- Does not cover Fang Accent Lights

COLOR	PART NUMBER
MATTE BLACK	2884732-458
INDY RED	2884732-293

TRAIL S '21-22, TRAIL '21-22



FRONT LOW PROFILE BUMPER

- 4.45 cm powder-coated steel tubing provides impact protection and aggressive styling

COLOR	PART NUMBER
MATTE BLACK	2884019-458
INDY RED	2884019-293

TRAIL S '21-22, TRAIL '21-22



FRONT WINCH BUMPER

- Elevated mounting location on bumper for easy access to 2,041 kg winch
- Requires winch (2885127, 2885126), sold separately

COLOR	PART NUMBER
MATTE BLACK	2884868-458

TRAIL S '21-22, TRAIL '21-22



REAR BUMPER EXTENSION

- Bumper extension quickly attaches to rear ROPS to provide additional taillight protection

COLOR	PART NUMBER
MATTE BLACK	2884734-458

TRAIL S '21-22, TRAIL '21-22 (US MODEL ONLY)



REAR DELUXE BUMPER

- Rear bumper extension expressly developed for EU-Models

COLOR	PART NUMBER
MATTE BLACK	2880164-458

TRAIL S '21-22 EU MODEL



FULL COVERAGE FENDER FLARES

- Keep the mud, dirt and debris from launching off the tires and into your face
- Includes two, front only

» 2881985
TRAIL S '21-22, TRAIL '21-22

> ROCK SLIDERS



10-GAUGE STAMPED STEEL
NO LOSS IN GROUND CLEARANCE

LOW PROFILE

COLOR	PART NUMBER
MATTE BLACK	2879498-458
INDY RED	2881587-293

TRAIL S '21-22, TRAIL '21-22



4.5cm STEEL TUBE CONSTRUCTION
EXTENDS FROM MACHINE FOR MAX
PROTECTION THROUGH ROUGH TERRAIN

EXTREME KICK-OUT

COLOR	PART NUMBER
MATTE BLACK	2879456-458
INDY RED	2881586-293

TRAIL S '21-22, TRAIL '21-22

ANCHOR MOUNTS

Tougher than conventional nuts and bolts, Expansion Anchor Mounts are engineered into every RZR, allowing for a fast install.

BUMPER ANCHOR PACK

- Four anchors and two bumper end caps included

» 2205114



UNEXPANDED EXPANDED

> STORAGE



LOCK & RIDE

48 L COOLER BOX

- One-piece, rotomolded construction for extreme durability
- Lid locks securely in place with rubber latches to protect cargo
- Heavy-duty hinges and weatherproof seal block moisture and dust
- Keeps food and beverages cool for 48+ hours, depending on conditions
- UV-fade resistant
- Installs quickly and easily without tools
- Easy to carry with integrated grab handles

» 2881556
TRAIL S '21-22, TRAIL '21-22

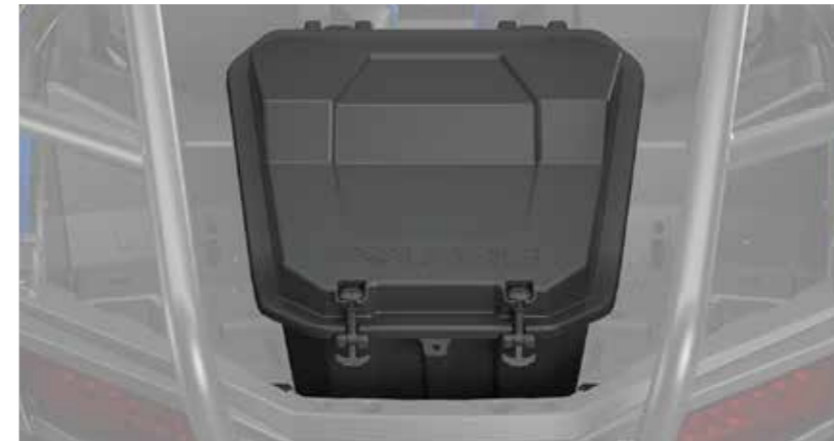

LOCK & RIDE

65 L CARGO BOX TOP SELLER

- Integrated rear cargo box, touting 65 L of storage
- Secure latching lid with taut rubber strap tie-downs
- Lightweight design integrates seamlessly into the rear cargo bed
- Includes all mounting hardware for complete installation

» 2881193
TRAIL S '21-22, TRAIL '21-22



SPARE TIRE CARRIER

- Mounts to rear ROPS to keep cargo bed free
- Compatible with Rear Bumper Extension (2884734-458)
- Quick installation

» 2884762
TRAIL S '21-22, TRAIL '21-22 (US MODEL ONLY)

BED D-RINGS

» 2877460
TRAIL S '21-22, TRAIL '21-22

LOCK & RIDE D-RINGS

» 2881544
TRAIL S '21-22, TRAIL '21-22





MIRRORS

SEE P. 85



> WINCHES

FEATURES	PRO PRO HEAVY DUTY SERIES	HD HEAVY DUTY SERIES
RAPID ROPE RECOVERY	STANDARD	NOT AVAILABLE
AUTO STOP TECHNOLOGY	STANDARD	OPTION
WINCH LINE	SYNTHETIC ROPE	STEEL CABLE
CONTROL	WIRELESS & WIRED STANDARD	WIRED STANDARD, WIRELESS OPTION
MODEL	2,041 kg	1,588 kg
TRAIL S '21-22 TRAIL '21-22	2885126	2885127

ADD REQUIRED CABLES
SEE P. 59 FOR BUS BAR HARNESS FITMENT
WINCH COVER KIT REQUIRED
2884118
TRAIL S '21-22, TRAIL '21-22

REPLACEMENT PARTS

15 M SYNTHETIC ROPE

2,041 kg SERIES
» 2879187

15 M STEEL CABLE

1,588 kg SERIES
» 2878890

UPGRADE YOUR HD WINCH

<p>WIRELESS REMOTE</p> <ul style="list-style-type: none"> • Up to 15 m range with LED indicator • Direct plug & play operation <p>» 2879316</p>	<p>AUTO STOP UPGRADE</p> <ul style="list-style-type: none"> • Billet aluminum • Replaces stock fairlead <p>» 2881693 <small>SYNTHETIC ROPE REQUIRED</small></p>
--	--



> HEATER



HEATER KIT

- Connects to Polaris PULSE Bus Bar to provide reliable, steady heat to your cab with fan speed and temperature control
 - Selectable vent positions include driver/passenger, defrost or a combination of both
 - Includes two defrost vents and two cabin vents
 - Compatible with subwoofer upgrade
- » 2884735
TRAIL S '21-22, TRAIL '21-22

> PLOWS



GLACIER HD PLOW SYSTEM

MAKE QUICK WORK OF SMALLER JOBS
Move snow with the tough and capable Glacier HD plow system and discover why a major snowfall can be the highlight of your week. With a robust frame, beefy poly and steel blade options, dismantling and amazing value, Glacier HD is a great choice in the dead of winter.



GLACIER HD GIVES YOU

- » 168 cm blades
- » Choice of poly or steel
- » Manual angle system standard

LOCK & RIDE

43 cm

168 cm POLY BLADE
BEST FOR CORROSION RESISTANCE

43 cm

168 cm STEEL BLADE
BEST FOR BIG JOBS YEAR AFTER YEAR

BUILD A PLOW SYSTEM

	STEP 1 SELECT A MOUNT	STEP 2 SELECT A FRAME	STEP 3 SELECT A LIFT METHOD	STEP 4 SELECT A BLADE	STEP 5 SELECT ACCESSORIES
MODELS	MOUNT	FRAME	WINCH	BLADES	ACCESSORIES
Trail S '21-22 Trail '21-22	<p>Glacier Pro Plow Mount 2884764</p> <p>2014-2020 Models: Glacier Pro Plow Mount 2880262</p> <p>S 900 '15-20, S 4 1000 '19-20, S 1000 '16-20, 900 '14-20</p>	<p>Glacier Pro HD Push Frame 2880260</p>	<p>Polaris Pro HD 2,041 kg Winch with Rapid Rope Recovery See P. 48 for details</p> <p>Polaris HD 1,588 kg Winch See P. 48 for details</p>	<p>Glacier Pro Plow Blade 168 cm Poly 2880269</p> <p>Glacier Pro Plow Blade 168 cm Steel 2880268</p>	<p>168 cm Snow Deflector 2879866</p> <p>168 cm HD Wear Bar 2879868</p> <p>168 cm Wear Bar 2879867</p> <p>Plow Marker 2872726</p> <p>Skid Shoe 2208864</p> <p>Shear Pin 2205527</p> <p>Plow Extension 2880267</p>

BUY A PLOW SYSTEM

NEW GLACIER HD PLOW SYSTEM

- System includes:
- Mount (2884764)
 - Frame (2880260)
 - 168 cm Poly Plow (2880269)
 - Plow Markers (2872726)

» 3880017
TRAIL S '21-22, TRAIL '21-22
REQUIRES WINCH



> LIGHTING & ELECTRICAL

> TRACKS



RIGID SR-SERIES 81 CM COMBO LED LIGHT BAR

- » LIGHT BAR
2884648
TRAIL S '21-22, TRAIL '21-22
- » MOUNT (REQUIRED)
2884650
TRAIL S '21-22, TRAIL '21-22
- » HARNESS (REQUIRED)
2884657
TRAIL S '21-22, TRAIL '21-22

ADDITIONAL LIGHTING OPTIONS
SEE P. 58



POLARIS PULSE UNDERHOOD BUS BAR - 6 POSITION

• If upgrading to have more than three accessories attaching to the underhood PULSE location, replace the 3 Position Bus Bar with the 6 Position Bus Bar

- » 2884183
TRAIL S '21-22, TRAIL '21-22



PLUG & PLAY ELECTRICAL

POLARIS PULSE IS A REVOLUTIONARY way to provide power to your vehicle, and makes adding electrical accessories a snap.

- Polaris-specific gearing provides 1:1 ratio to:
- Minimize track slip, providing better climbing ability and improved traction in deep snow
 - Improve top speed over prior models by approximately 5%
 - Reduce operating RPM for a quieter ride
 - Improve driveline durability, which allows vehicle to run at a lower RPM, decreasing engine wear

New front dual stabilizer for improved stability

Polaris exclusive optimized hub geometry that minimizes feedback and eases steering effort

Lightweight design provides for better flotation, eases steering effort and provides better vehicle control

Flexible lug design provides the highest level of deep snow performance by lifting up, as opposed to digging down



TRACKS

- » **NON-EPS MODELS • 2880757**
20 FRONT, 18 REAR
FOR USE ON MODELS WITHOUT FACTORY EPS:
TRAIL S '21-22, TRAIL '21-22, S 900 '15-20, S 4 1000 '20, S 1000 '18-20, 900 '15-20
- » **EPS MODELS • 2880758**
18 FRONT, 18 REAR
FOR USE ON MODELS WITH FACTORY-INSTALLED EPS:
TRAIL S '21-22, TRAIL '21-22, S 900 '15-20, S 4 1000 '19-20, S 1000 '16-20, 900 '15-20

MOUNTS

- » **NON-EPS MODELS • 2880648**
FITS THE FOLLOWING 50" WIDE MODELS:
TRAIL '21-22, 900 '14-20
- » **EPS MODELS • 2880649**
FITS THE FOLLOWING 60" WIDE MODELS:
TRAIL S '21-22, S 900 '15-20, S 4 1000 '19-20, S 1000 '16-20, 900 '15-20

PLOW EXTENSION (2880267) REQUIRED FOR USING A PLOW WITH TRACKS
ONLY COMPATIBLE WITH GLACIER PRO HD SYSTEM

> ROOFS



LOCK & RIDE

POLY SPORT ROOF TOP SELLER

- Rigid, injection-molded design to eliminate warping in high-heat conditions
- Integrated mounting locations for lighting
- Rugged, textured polyethylene construction for impact and abrasion resistance
- Not compatible with Canvas Upper Doors

COLOR	2-SEAT	4-SEAT	NOT SHOWN
MATTE BLACK	2883073	2883074	
	S 900 '15-20, S 1000 '16-20, 900 '15-20	S 4 1000 '19-20	

GRAPHIC SPORT ROOF

- Weighs only 5 kg (30% lighter than aluminum)
- Won't bend or break upon impact with debris or obstacles
- Sunroof lets in sunlight while keeping you shaded from heat

COLOR	2-SEAT	4-SEAT	NOT SHOWN
MATTE BLACK	2881206	2881935	
INDY RED	2881607	2881936	
	S 900 '15-20, S 1000 '16-20, 900 '14-20	S 4 1000 '19-20	

ALUMINUM ROOF TOP SELLER

- Seals to the vehicle frame for the best protection and great integration with other RZR accessories
- Strong and durable 5051 aluminum construction for long-lasting, reliable protection

COLOR	2-SEAT	4-SEAT	NOT SHOWN
MATTE BLACK	2881582-458	2881592-458	
INDY RED	2881582-293	2881592-293	
	S 900 '15-20, S 1000 '16-20, 900 '14-20	S 4 1000 '19-20	

> DOORS



ALUMINUM DOORS

- Single-piece stamped aluminum maximizes quality, fit and finish
- Gasket design eliminates rattling and creates a firm seal
- Available with RZR-matched graphics

- » 2-SEAT • 2879510
S 900 '15-20, S 1000 '16-20, 900 '15-20
- » 4-SEAT • 2879943
S 4 1000 '19-20



LOWER DOOR INSERTS TOP SELLER

- Covers the bottom of the door opening, shutting out water and dust
- Durable plastic construction with steel frame
- Includes optional rear bolster panels, not compatible on some models

- » 2-SEAT • 2879509
S 900 '15-20, S 1000 '16-20
- » 4-SEAT • 2879942
S 4 1000 '19-20

> STORAGE



LOWER DOOR STORAGE BAG

- » 127 cm • 2880616
900 '14-20
REQUIRES LOWER DOOR (2880207)
ONLY COMPATIBLE WITH FRONT DOORS



SEE P. 85 FOR MIRRORS



OVERHEAD BAG

- » 2879516
S 900 '15-20, S 4 1000 '19-20, S 1000 '16-20, 900 '14-20

> WINCHES

FEATURES	PRO PRO HEAVY DUTY SERIES	HD HEAVY DUTY SERIES	
RAPID ROPE RECOVERY	STANDARD	NOT AVAILABLE	
AUTO STOP TECHNOLOGY	STANDARD	OPTION	
WINCH LINE	SYNTHETIC ROPE	STEEL CABLE	
CONTROL	WIRELESS STANDARD, WIRED OPTION	WIRED STANDARD, WIRELESS OPTION	
MODEL	2,041 kg	1,588 kg	ADD REQUIRED CABLES
	TOP SELLER 2882240	2881671	SEE P. 59 FOR BUS BAR HARNESS FITMENT

REPLACEMENT PARTS

15 M SYNTHETIC ROPE

- 2,041 kg SERIES
» 2879187



15 M STEEL CABLE

- 1,588 kg SERIES
» 2878890



UPGRADE YOUR CONTROLS **UPGRADE YOUR HD WINCH**

WIRED REMOTE CONTROL

- Must order remote handle and socket together

- » REMOTE HANDLE 4013466
- » SOCKET 4014228
- WORKS WITH 2882240
- WORKS WITH 2882240

WIRELESS REMOTE

- Up to 15 m range with LED indicator
- Direct plug & play operation

- » 2879316

AUTO STOP UPGRADE

- Billeted aluminum
- Replaces stock fairlead

- » 2881693
- SYNTHETIC ROPE REQUIRED

> ROCK SLIDERS

LOW PROFILE ROCK SLIDERS

- Plated steel construction, durable powdercoat finish
- Easy installation with expanded anchor mount

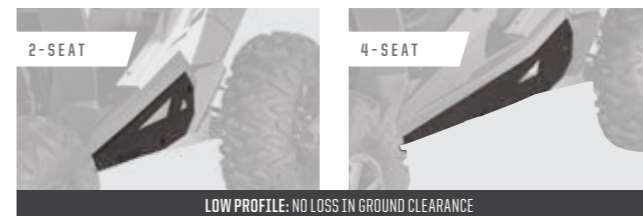

COLOR	2-SEAT	4-SEAT
MATTE BLACK	2879498-458	2879940-458
INDY RED	2881587-293	2881593-293
SKY BLUE	2881587-737	2881593-737

S 900 '15-20, S 1000 '16-20, 900 '14-20 S 4 1000 '19-20

EXTREME KICK-OUT ROCK SLIDERS

- Rugged steel protection and race-inspired styling
- Low-profile mounting location will not diminish ground clearance

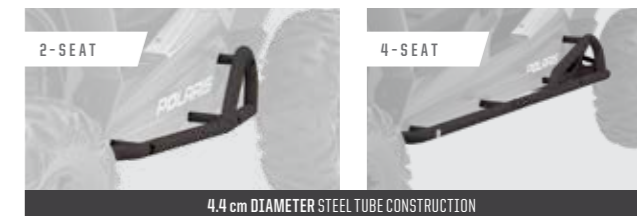

COLOR	2-SEAT	4-SEAT
MATTE BLACK	2879456-458	2882079-458
INDY RED	2881586-293	2882079-293
SKY BLUE	2881586-737	2882079-737

S 900 '15-20, S 1000 '16-20, 900 '14-20 S 4 1000 '19-20

> BUMPERS

LOW PROFILE BUMPER

- Provides more protection and allows for accessory mounting



4.4 cm DIAMETER STEEL TUBE CONSTRUCTION

COLOR	PART NUMBER
MATTE BLACK	2879449-458
INDY RED	2881583-293

S 900 '15-20, S 4 1000 '19-20, S 1000 '16-20, 900 '14-20

EXTREME BUMPER ATTACHMENT

- Provides increased protection around lighting and fenders



4.4 cm DIAMETER STEEL TUBE CONSTRUCTION

COLOR	PART NUMBER
MATTE BLACK	2879451-458

S 900 '15-20, S 4 1000 '19-20, S 1000 '16-20, 900 '14-20
REQUIRES LOW PROFILE FRONT BUMPER (2879449-458, 2881583-293)

FROM DUSK

Extend your ride time and be more visible to others with the brightest light bars in the industry.

RIGID LIGHT BARS P.58

A trusted name in the off-road lighting industry, RIGID delivers unmatched technology and superior performance.

'TIL DAWN

PRO ARMOR LIGHT BARS P.59

Pro Armor gives you aggressive styling, rugged protection and lighting solutions for your riding needs.



BUILD YOUR VISION

OPTICS

ACCENT

USAGE

DIFFUSED COLORED LIGHT ADDED FOR STYLE & PERSONALIZATION

- Durable, dust and water resistant construction
- Ideal for showcasing your lifted vehicle or custom suspension



DRIVING

GREAT FOR ALL RIDING STYLES, TERRAINS OR WORK APPLICATIONS

- Beam: Extra-wide, moderate center intensity
- Recommended Mounting: All points



FLOOD

BEST FOR WIDE-OPEN TERRAINS OR WORK APPLICATIONS REQUIRING BROAD LIGHT

- Beam: Wide, shorter
- Recommended Mounting: Low & rear
- Ideal for medium speeds when peripheral vision is important



SPOT

BEST FOR TIGHT RIDING TERRAINS AND CONDITIONS REQUIRING LONG-DISTANCE VISIBILITY

- Beam: Concentrated long beam
- Recommended Mounting: High
- Ideal for high speeds so you can see and react to your environment



COMBO

ALL-AROUND VERSATILITY FOR ANY RIDING TERRAIN, CONDITION OR WORK APPLICATION

- Beam: Combination of flood and spot optics
- Recommended Mounting: All points
- Ideal for all-around distance visibility



DRIVING SPEED

ALL

SLOW TO MEDIUM

SLOW TO MEDIUM

HIGH

ALL

LIGHT ANGLE

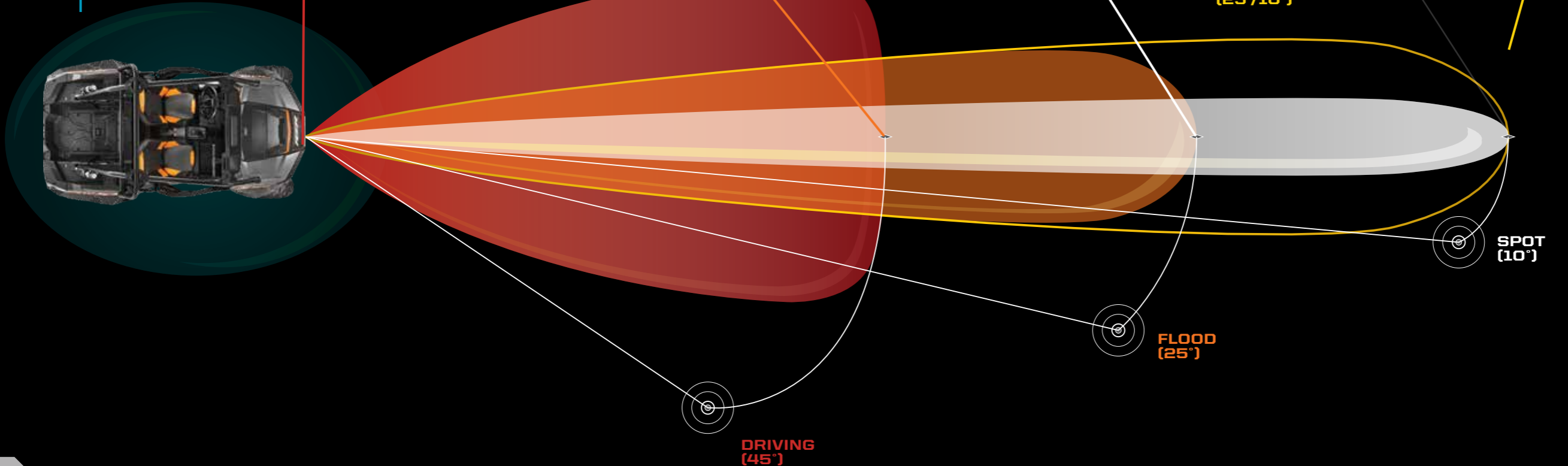

COMMON

LIGHTING

CONNECTED TECHNOLOGY

AUDIO

WHEELS & TIRES

VEHICLE & RIDER PROTECTION

COOLERS

COCKPIT ACCESSORIES & MIRRORS

WINCHES

MISC. STG & YOUTH



POLARIS ENGINEERED ADVANTAGES

MOUNTS PERFECTLY
Designed for your Polaris Engineered bumper, roof or other mounting point

MAX PERFORMANCE
Validated to work as hard as your machine does

DOESN'T OVERTAX
Trust it to work when you need it to



ADVANCED TECH

RIGID lights are driven by Aluminum PCB Smart Boards, 6063-T5 aircraft aluminum extruded housings and Tiger Drylac UV protection polyester powder-coating.

EXCLUSIVE OPTICS

RIGID invests heavily in optical science and has patented multiple optics and optics systems, maximizing light output and efficiency.

RUGGED CONSTRUCTION

Pro Armor lights are designed to be big and beefy with an aggressive style all their own, and housed in IP67 marine-grade rated UV polyester powder-coating.

MASSIVELY BRIGHT

Pro Armor builds bright lights designed for any riding experience. All that power is directed through heat dissipating aluminum for streamlined heat management.

LIGHT BAR TYPES



SR-SERIES PRO

Sleek, powerful, low-profile (under 5 cm tall). Lights extreme distances with low energy usage.
Available in 25.4 cm & 81.3 cm



D-SERIES PRO

Compact to fit almost anywhere with high output and low energy usage.
Available in Driving, Flood & Spot



DUAL-ROW LED LIGHT BARS

The most spread and farthest illumination downrange. Easy to mount.
Available in Cube, 25.4 cm, 50.8 cm & 76.2 cm



SINGLE-ROW LED LIGHT BARS

Powerful, compact, low-profile light bars with a sleek look.
Available in 27.9 cm & 83.8 cm



CUBE LED LIGHTS

Small size allows mounting in strategic locations for added lighting.
Available in Flood & Spot

LIGHT BAR OPTIONS

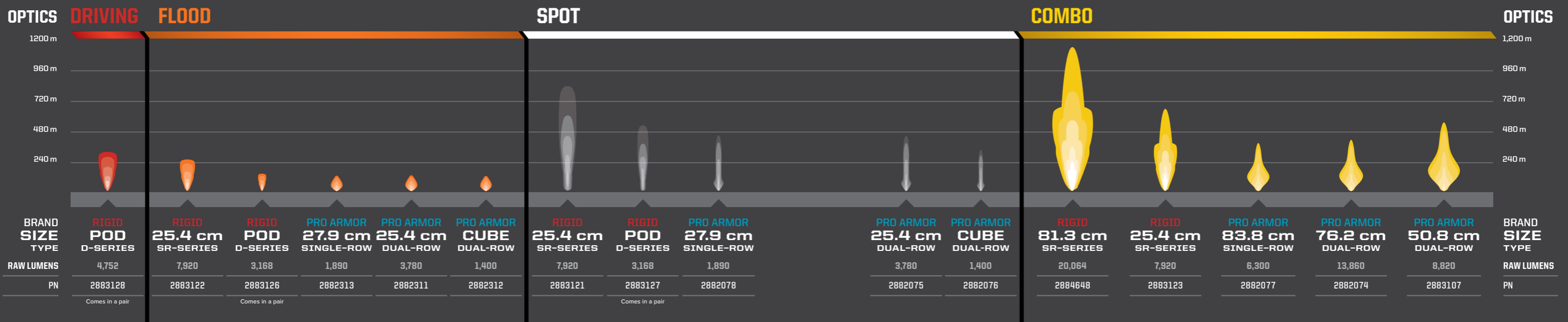

FANG ACCENT LIGHTS TOP SELLER

- Includes a pair of front fascia accent lights and a rear, center taillight (rear light with kit only)
- Durable dust and waterproof construction
- FRONT/REAR KIT • 2884053
TURBO S '19-21, XP TURBO '19-21, TURBO S 4 '19-21, XP 4 TURBO '19-21, XP 4 1000 '19-22, XP 1000 '19-22
- FRONT • 2884871
TRAIL S '21-22, TRAIL '21-22, TURBO S '19-21, XP TURBO '19-21, TURBO S 4 '19-21, XP 4 TURBO '19-21, XP 4 1000 '19-22, XP 1000 '19-22



ADD A HARNESS TO MOUNT YOUR LIGHTS

MODEL	LIGHT BAR SET-UPS		
	1 LIGHT IN 1 LOCATION ON 1 SWITCH	2 LIGHTS IN 2 LOCATIONS ON 1 SWITCH	2 LIGHTS IN 2 LOCATIONS ON 2 SWITCHES
TRAIL S '21-22 TRAIL '21-22	LIGHT BAR HARNESS 2884657	LIGHT BAR HARNESS 2884657 ADAPTER HARNESS 2412616 LED Y-HARNESS 2879860	LIGHT BAR HARNESS (x2) 2884657
PRO R 4 '22 PRO R '22 PRO XP 4 '20-22 PRO XP '20-22 TURBO R 4 '22 TURBO R '22	LIGHT BAR HARNESS 2883949 ADAPTER HARNESS 2412616	LIGHT BAR HARNESS 2883949 ADAPTER HARNESS 2412616 LED Y-HARNESS 2879860	LIGHT BAR HARNESS (x2) 2883949 ADAPTER HARNESS (x2) 2412616
RS1 '18-22	LIGHT BAR HARNESS 2883388	LIGHT BAR HARNESS 2883388 LED Y-HARNESS 2879860	LIGHT BAR HARNESS (x2) 2883388
TURBO S '18-21, TURBO S 4 '19-21 XP TURBO '15-21, XP 4 TURBO '16-21 XP 1000 '14-22, XP 4 1000 '14-22 S 1000 '16-20, S 4 1000 '19-20 S 900 '15-20, 900 '14-20	LIGHT BAR HARNESS 2883486	LIGHT BAR HARNESS 2883486 LED Y-HARNESS 2879860	LIGHT BAR HARNESS (x2) 2883486

ADD BATTERY CONNECTION CABLES FOR POWER

BUS BAR HARNESSES	
MODEL	BUS BAR HARNESS
PRO R 4/PRO R '22 PRO XP 4/PRO XP '20-22 TURBO R 4/TURBO R '22 TRAIL S '21-22, TRAIL '21-22 RS1 '18-22 XP 4 TURBO/XP TURBO '17-21 XP 4 1000/XP 1000 '18-22 TURBO S 4 '19-21, TURBO S '18-21	HARNESS NOT REQUIRED
S 900 '16-20 S 1000 '16-20 900 '15-20	2881551
S 4 1000 '19-20	2881646

PULSAR Electrical System All RIGID and Pro Armor lights are Polaris PULSE ready.

PRO R, TURBO R & PRO XP LIGHT BAR OPTIONS

SEE P. 24

COMMON
LIGHTING
CONNECTED TECHNOLOGY
AUDIO
WHEELS & TIRES
VEHICLE & RIDER PROTECTION
COOLERS
COCKPIT ACCESSORIES & MIRRORS
WINCHES
MISC. STG & YOUTH

> CONNECTED TECHNOLOGY



POLARIS RIDECOMMAND

PLAN. TRACK. SHARE. CONNECT.

PLAN YOUR RIDE

Plan an epic ride with stops along the way, customize and adjust your path to maximize your route or follow turn-by-turn directions. You can even share your planned route with friends.

DISCOVER NEW TRAILS

With almost 1,000,000 miles of trails available offline, you'll have the confidence to explore further, whether you have cellular coverage or not.

RELIVE YOUR RIDE

With 3D flyovers you can track and go over your completed rides, and share your favorite routes with friends even after the ride is over.

7" DISPLAY POWERED BY RIDE COMMAND

- Bright, 7" touchscreen visible in all conditions
- **Pre-Loaded Maps**
Available offline on the in-dash display so you always know where you are.
- **Route Planning**
Add points of interest and waypoints to make the most of your off-road adventure.
- **Camera Integration**
Navigate with full view of your surroundings. Use the integrated rear camera to see others behind you while riding.
- **Personalized Audio Experience**
Seamlessly pair your display via Bluetooth to wirelessly stream music and stay connected with call and text alerts.
- **Configurable Gauges**
Customize your ride experience with elevation, travel direction, fuel level and more to create relevant screens for you.

» 2884072
PRO R 4 '22, PRO R '22, TURBO R 4 '22, TURBO R '22, PRO XP 4 '22, PRO XP '22, TRAIL S '21-22, TRAIL '21-22, TURBO S '19-21, XP TURBO '19-21, TURBO S 4 '19-21, XP 4 TURBO '19-21, XP 4 1000 '19-22, XP 1000 '19-22

7" DISPLAY MOUNT KIT

- Replaces dash for seamless fit and finish
- Includes front and rear cameras with mounts
- Comes with wiring harnesses needed for RZR accessory components
- **RIDE COMMAND Audio Adapter (2883232)** required when adding audio to an XP

» 2884584
PRO R 4 '22, PRO R '22, TURBO R 4 '22, TURBO R '22, PRO XP 4 '20-22, PRO XP '20-22

» 2884021
TURBO S '19-21, XP TURBO '19-21, TURBO S 4 '19-21, XP 4 TURBO '19-21, XP 4 1000 '19-22, XP 1000 '19-22

» 2884731
TRAIL S '21-22, TRAIL '21-22

FRONT CAMERA KIT TOP SELLER

- Front camera upgrade for increased visibility and safety
- Increases driver awareness of obstacles and terrain for enhanced riding
- All wiring harnesses included on vehicle

» 2884432
PRO R 4 '22, PRO R '22, TURBO R 4 '22, TURBO R '22, PRO XP 4 '20-22, PRO XP '20-22, TRAIL S '21-22, TRAIL '21-22, TURBO S '19-21, XP TURBO '19-21, TURBO S 4 '19-21, XP 4 TURBO '19-21, XP 4 1000 '19-22, XP 1000 '19-22

COMMON

LIGHTING

CONNECTED TECHNOLOGY

AUDIO

WHEELS & TIRES

VEHICLE & RIDER PROTECTION

COOLERS

COCKPIT ACCESSORIES & MIRRORS

WINCHES

MISC. STOR. & YOUTH

SEE NEXT PAGE TO ADD AUDIO

OFF-ROAD GRADE AUDIO

BUILD YOUR AUDIO SYSTEM



When you research audio solutions, you'll see manufacturers bragging about how their audio equipment is "Marine Grade." Or worse yet, you'll discover they are repackaged components built for automotive applications. MB Quart, in partnership with Polaris, engineers Off-Road Grade Audio equipment that's proven to deliver the loudest, crispest sound in the harshest conditions. Rain, snow, mud, heat, cold, dust — **ANY PLACE YOUR RZR EXCELS, SO WILL YOUR AUDIO.**

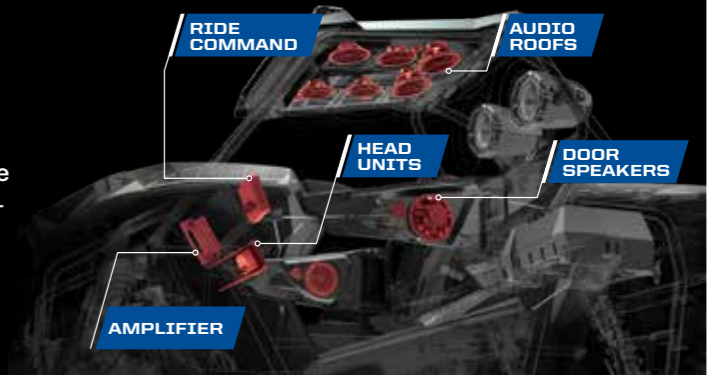

1 CHOOSE A HEAD UNIT Control all aspects of your sound system. Choose what to listen to and how loud.

7" DISPLAY POWERED BY RIDE COMMAND



- Total command center for a world of connection at your fingertips
- Media player with built in AM/FM tuner for all your favorite music*
- Built in GPS with topography maps to see your location and plan your ride
- Group Ride allows you to see your friends on the map with buddy tracking
- Track and share ride stats on the display or in the RIDE COMMAND mobile app

» 2884072

PRO R 4 '22, PRO R '22, TURBO R 4 '22, TURBO R '22, PRO XP 4 '22, PRO XP '22, TRAIL S '22, TURBO S '19-21, XP TURBO '19-21, TURBO S 4 '19-21, XP 4 TURBO '19-21, XP 4 1000 '19-22, XP 1000 '19-22
SEE P. 60 FOR REQUIRED MOUNT OPTIONS

SEE P. 60 FOR MORE INFO

2 ADD SPEAKERS

Build your dream audio system. From a simple setup with only door speakers, to a complex system with door speakers, audio pods and a subwoofer — BUILD IT YOUR WAY.



DOOR SPEAKERS TOP SELLER

- High performance 16.5 cm component speakers with 1.9 cm titanium dome tweeters
- Harnessing included to connect to audio amplifier
- Works with Polaris Aluminum Door kits or Polaris Lower Door kits
- Requires Audio Amplifier (2883738, 2884064) when used with RIDE COMMAND

- » **FRONT • 2881989** (Set of two)
TURBO S '18-21, XP TURBO '15-21, TURBO S 4 '19-21, XP 4 TURBO '15-21, XP 4 1000 '14-22, XP 1000 '14-22, S 900 '15-20, S 4 1000 '19-20, S 1000 '16-20
NOT COMPATIBLE WITH DYNAMIX ACTIVE SUSPENSION MODELS
- » **REAR • 2883116** (Set of two)
TURBO S 4 '19-21, XP 4 TURBO '16-21, XP 4 1000 '14-22, S 4 1000 '19-20
REQUIRES FRONT DOOR SPEAKERS (2881989). CONNECTS DIRECTLY TO AUDIO AMPLIFIER (2884064). NO ADDITIONAL AMPLIFIER NEEDED.
NOT COMPATIBLE WITH AUDIO ROOFS.

3 MAKE IT WORK

BUS BAR HARNESS

VEHICLE FITMENT	BUS BAR HARNESS
RS1 '18-22 XP TURBO/XP 4 TURBO '17-21 XP 1000/XP 4 1000 '18-22 TURBO S '18-21, TURBO S 4 '19-21	HARNESS NOT REQUIRED
S 900 '16-20, 900 '15-20 S 1000 '16-20	2881551
S4 1000 '19-20	2881646

AUDIO Y-HARNESS

- Y-Harness splits the audio signal to allow for additional audio components to be added
- » 2883269
TURBO S '18-21, XP TURBO '19-21, TURBO S 4 '20-21, XP 4 TURBO '19-21, XP 4 1000 '14-22, XP 1000 '14-22, S 900 '15-20, S 4 1000 '19-20, S 1000 '16-20, 900 '14-20

LINE-OUT AUDIO HARNESS

- Designed to extend JST audio signal from rear of audio roof to the front of the vehicle
- » 2881652
TURBO S '18-21, XP TURBO '19-21, TURBO S 4 '20-21, XP 4 TURBO '19-21, XP 4 1000 '14-22, XP 1000 '14-22, S 900 '15-20, S 4 1000 '19-20, S 1000 '16-20, 900 '14-20

RIDE COMMAND ONLY

RIDE COMMAND AUDIO ADAPTER

- Required to hook up any audio RIDE COMMAND system
- Connect up to two speaker options and subwoofer
- Specifically designed for subwoofer

- » 2883232
TURBO S '18-21, XP TURBO '19-21, TURBO S 4 '20-21, XP 4 TURBO '19-21, XP 4 1000 '14-22, XP 1000 '14-22, S 900 '15-20, S 4 1000 '19-20, S 1000 '16-20, 900 '15-20
REQUIRED WHEN ADDING AUDIO TO 7" DISPLAY (2884072)
DOOR SPEAKERS AND AUDIO AMPLIFIER NOT RECOMMENDED WITH DYNAMIX ACTIVE SUSPENSION MODELS

SOUND BARS ONLY

SPEAKER BAR HARNESS

- Used to connect sound bar to accessory bus bar for power
- » 2882280
TURBO S '18-21, XP TURBO '19-21, TURBO S 4 '20-21, XP 4 TURBO '19-21, XP 4 1000 '14-22, XP 1000 '14-22, S 900 '15-20, S 4 1000 '19-20, S 1000 '16-20, 900 '14-20
BUS BAR HARNESS (2881551, 2881646) REQUIRED

DOOR SPEAKERS ONLY

AUDIO AMPLIFIER

- 200-watt, TDA-based, full-range, Class D amplifier with fixed connections for power, ground and turn-on and Delphi connectors for door speakers
 - Required with Door Speakers (2881989, 2883116)
- » 2883738
S 900 '15-20, S 4 1000 '19-20, S 1000 '16-20, 900 '15-20
- » 2884064
TURBO S '19-21, XP TURBO '19-21, TURBO S 4 '20-21, XP 4 TURBO '19-21, XP 4 1000 '19-22, XP 1000 '19-22

AUDIO ROOF



- Use as an all-in-one solution or a base unit to build your system
- Four high-efficiency 16.5 cm coaxial speakers for unbeatable sound
- Built in push-button dash radio with Bluetooth and AUX
- Modular design for improved serviceability and access
- Not compatible with RIDE COMMAND

S4 AUDIO ROOF

- » 2882064
XP TURBO '15-21, XP 1000 '14-22, S 900 '15-20, S 1000 '16-20, 900 '14-20

S8 AUDIO ROOF

- » 2882065
XP TURBO '15-21, XP 1000 '14-22, S 900 '15-20, S 1000 '16-20, 900 '14-20

MODEL:	S4	S8
(4) 16.5 cm COAXIAL SPEAKERS	✗	✗
(4) 16.5 cm COMPONENT SPEAKERS, MIDS & TWEETERS		✗
(2) 15.2 cm x 22.9 cm COAXIAL SPEAKERS		
4-CHANNEL, 2-DHM, 300W AMPLIFIER		✗
83.8 cm SINGLE-ROW PRO ARMOR LIGHT BAR		✗
76.2 cm DUAL-ROW PRO ARMOR LIGHT BAR		
DOME LIGHT		✗

SOUND BAR

- All-in-one solution for a quick and easy audio upgrade to your machine

SOUND BAR 8

- Six mid-range/mid-bass speakers and two dedicated tweeters
- Fully waterproof with large, easy-to-use external controls

- » 2881465
XP TURBO '15-21, XP 1000 '14-22, XP 4 TURBO '16-21, XP 4 1000 '14-22, S 900 '15-20, S 4 1000 '19-20, S 1000 '16-20, 900 '14-20
SPEAKER BAR HARNESS (2882280) REQUIRED

SOUND BAR 4

- Two mid-range/mid-bass speakers and two dedicated tweeters

- » 2881230
XP TURBO '15-21, XP 1000 '14-22, XP 4 TURBO '16-21, XP 4 1000 '14-22, S 900 '15-20, S 4 1000 '19-20, S 1000 '16-20, 900 '14-20
SPEAKER BAR HARNESS (2882280) REQUIRED

NOT COMPATIBLE WITH ADDITIONAL/EXTERNAL SPEAKERS OR RIDE COMMAND



Sound Bar 8



Sound Bar 4

COMMON

LIGHTING

CONNECTED TECHNOLOGY

AUDIO

WHEELS & TIRES

VEHICLE & RIDER PROTECTION

COOLERS

COCKPIT ACCESSORIES & MIRRORS

WINCHES

MISC. STO & YOUTH



PRO ARMOR TIRES



DOMINATE ANY ENVIRONMENT

FIND THE RIGHT PRO ARMOR TIRE FOR YOUR RZR

Developed and tested with Polaris engineers, ensuring the perfect fit and optimal performance mile after mile.



For off-road use only. Please check fitment with your dealer.

COMMON

LIGHTING

CONNECTED TECHNOLOGY

AUDIO

WHEELS & TIRES

VEHICLE & RIDER PROTECTION

COOLERS

COCKPIT ACCESSORIES & MIRRORS

WINCHES

MISC. STYLING & YOUTH

65

64

KNOW YOUR TERRAIN



- Tread patterns optimized for extreme traction
- Ideal for both hard-pack and loose trail



- Flexible "grippy" tread
- Aggressive side bite



- Provides traction and durability
- Built to perform in hard sand, jagged rocks or any other extreme terrain



- Extra deep treads
- Self-cleaning lugs



- Paddles provide traction and durability in soft sand
- Built to float on top of sand



- Triple-belted sidewalls to resist puncture
- Purpose-built, long lasting tread patterns



- Handles extreme cold
- Holds shape and provides traction

SUPERIOR PERFORMANCE & DURABILITY

WAYS TO SHOP WHEELS & TIRES

LIFELONG PERFORMANCE

- Every tire is designed and constructed with longevity in mind
- 3,000+ mile rated (4,828 kilometers)

PREMIUM PROTECTION

- Pro Armor makes tires with extra protection exactly where it's needed most — the sidewall
- Triple-belted sidewalls keep your tires more resistant so you can keep going

TOUGH TIRES

- Higher ply ratings mean added protection
- Pro Armor builds 8 or 10-ply rated tires for higher puncture-resistance



KNOW YOUR TIRES

DIMENSIONS			TREAD DEPTH	TIRE WEIGHT	PLY RATING	SIDEWALL BELTS	LOAD RATING
TIRE HEIGHT	TIRE WIDTH	WHEEL DIAMETER					
32" x 9"	R15	FRONT/REAR	30mm	18 kg	10	3	499 kg
Part Number			TREAD DEPTH Deeper treads have more grip in all conditions	PLY RATING Indicates tire puncture-resistance	LOAD RATING How much weight can the tire handle	SIDEWALL BELTS Increase your resistance to sidewall punctures	USAGE Where can you use the tire
			TIRE WEIGHT A lighter tire makes for improved vehicle performance				

TIRES BY SIZE

26"	27"	28"	29"	30"	32"	33"
DUAL-THREAT	MUD XC	ATTACK 2.0	MUD XC	ATTACK 2.0	DUAL-THREAT	CRAWLER XR
ATTACK	WHITEOUT	CRAWLER XR	DUAL-THREAT	SAND 12XT	CRAWLER XG	PRO RUNNER
		CRAWLER XG	HD-K	CRAWLER XG	CRAWLER XR	
				WHITEOUT	SAND 16XT	
				PRO RUNNER	PRO RUNNER	
				CRAWLER AT	MUD XT	
				SAND 16XT	CRAWLER AT	

TIRES BY TERRAIN

TRAIL	ROCK	DESERT	MUD	SAND	SNOW
ATTACK 2.0	ATTACK 2.0	ATTACK 2.0	MUD XC	SAND 12XT	ATTACK 2.0
ATTACK	DUAL-THREAT	ATTACK	MUD XT	SAND 16XT	ATTACK
DUAL-THREAT	CRAWLER XR	DUAL-THREAT			WHITEOUT
MUD XC	CRAWLER XG	CRAWLER XR			HD-K
CRAWLER XR	PRO RUNNER	CRAWLER XG			
CRAWLER XG	CRAWLER AT	PRO RUNNER			
PRO RUNNER		CRAWLER AT			
HD-K					
CRAWLER AT					

WHEELS BY SIZE

14"	15"	16"
40-SERIES (8 TIRE OPTIONS)	50-SERIES (9 TIRE OPTIONS)	60-SERIES (1 TIRE OPTION)
4201	5101	6301 BEADLOCK
4202	5201	
4203 BEADLOCK	5202	
4204	5203 BEADLOCK	
4205	5204	
4206	5205	
4301 BEADLOCK	5206	
4302 BEADLOCK	5207	
4303	5301 BEADLOCK	
HD DUAL BEADLOCK	5302 BEADLOCK	
	5303	

KNOW YOUR WHEELS

STEP 1: SELECT YOUR SERIES

4 = 40-SERIES 5 = 50-SERIES 6 = 60-SERIES

STEP 2: CHOOSE YOUR LOAD RATING

1 = <362.9 kg 2 = 363 - 589.7 kg 3 = 590 - 726+ kg

STEP 3: PICK YOUR STYLE

OFFSET / BEADLOCK / COLOR

INCREASE OFFSET FROM STOCK = NARROWER STANCE
DECREASE OFFSET FROM STOCK = WIDER STANCE

COMMON
LIGHTING
CONNECTED TECHNOLOGY
AUDIO
WHEELS & TIRES
VEHICLE & RIDER PROTECTION
COOLERS
COCKPIT ACCESSORIES & MIRRORS
WINCHES
MISC. STG & YOUTH

TIRES



FRONT/REAR

PRO ARMOR ATTACK 2.0

- Engineered for excellent hard-pack performance
- Dual-compound technology and radial construction offer performance in all terrains
- Tight thread pattern for quieter ride

	TREAD DEPTH	TIRE WEIGHT	PLY RATING	SIDEWALL BELTS	LOAD RATING
15" 28" x 10" R15 5416344	FRONT/ REAR 25mm	15 kg	10	3	499 kg
15" 30" x 10" R15 5416345		17 kg			560 kg



FRONT/REAR

PRO ARMOR DUAL-THREAT

- Dual-compound technology and radial construction offer performance in all terrains
- Softer durometer rubber on outer edge for overall superior grip and feel
- Harder durometer rubber in the middle for increased traction during acceleration and longer tread life

	TREAD DEPTH	TIRE WEIGHT	PLY RATING	SIDEWALL BELTS	LOAD RATING
14" 26" x 9" R14 5416340	FRONT	12 kg	10	3	413 kg
14" 26" x 11" R14 5416341					504 kg
14" 29" x 9" R14 5416342	FRONT	14 kg	10	3	504 kg
14" 29" x 11" R14 5416343					599 kg
15" 32" x 10" R15 5416753	FRONT/ REAR	17 kg			902 kg



ATTACK 2.0

TIGHTER TREAD PATTERN =
Better traction in hard-pack

DUAL-DUROMETER LUG =
Increased grip & traction in rough terrain, smoother ride in all terrain

10-PLY RATED =
Increased durability

LARGER 28" & 30" SIZE OFFERING =
More ground clearance & trail traction

DUAL-COMPOUND = MORE GRIP + LONGER LIFE

Firmer Durometer Rubber =
Longer Life

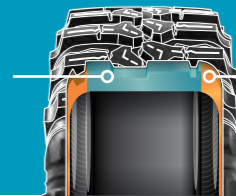

Softer Durometer Rubber =
More Grip



FRONT/REAR

PRO ARMOR ATTACK

- The best all-purpose tire for all-season traction in any terrain
- Unique, full-face tread design
- Harder durometer lugs promote extended wear, increasing tire life
- Wider spaced lugs provide more grip in softer terrain

	TREAD DEPTH	TIRE WEIGHT	PLY RATING	SIDEWALL BELTS	LOAD RATING
14" 26" x 9" R14 5415613	FRONT	13 kg	8	3	413 kg
14" 26" x 11" R14 5415614					599 kg



FRONT/REAR

PRO ARMOR PRO RUNNER

- Designed to be lightweight, high-performance and quicker in corners/flats
- Triple-belted sidewalls offer extra protection where it's needed the most
- Lug separation provides a great grip and an easy clean in mud and sand

	TREAD DEPTH	TIRE WEIGHT	PLY RATING	SIDEWALL BELTS	LOAD RATING
15" 30" x 9" R15 5417531	FRONT/ REAR	14mm	8	3	531 kg
15" 32" x 9.5" R15 5417532					630 kg
15" 33" x 9.5" R15 5417533					671 kg



COMMON

LIGHTING

CONNECTED TECHNOLOGY

AUDIO

WHEELS & TIRES

VEHICLE & RIDER PROTECTION

COOLERS

COCKPIT ACCESSORIES & MIRRORS

WINCHES

MISC. STG. & YOUTH

69

TIRES



PRO ARMOR CRAWLER XR

- Premium grip for all terrains, from the trail to the rocks
- Square block profile for even surface contact
- A tougher durometer than the XG to take on the toughest a trail has to offer

	TREAD DEPTH	TIRE WEIGHT	PLY RATING	SIDEWALL BELTS	LOAD RATING
14" 28" x 10" R14 5415536	FRONT/ REAR 16mm	15 kg	8	3	517 kg
15" 32" x 10" R15 5416114		18 kg			630 kg
15" 33" x 10" R15 5417174		18 kg			630 kg



PRO ARMOR CRAWLER XG

- Built to crawl over all obstacles, both large and small
- A soft, sticky compound makes this tire ideal for both rock crawling and desert running
- 8-ply, triple-belted ballistic sidewalls resist punctures

	TREAD DEPTH	TIRE WEIGHT	PLY RATING	SIDEWALL BELTS	LOAD RATING
14" 30" x 10" R14 5415616	FRONT/ REAR 20mm	17 kg	8	3	581 kg
14" 32" x 10" R14 5416113		19 kg			644 kg
15" 28" x 10" R15 5416346		15 kg			499 kg
15" 30" x 10" R15 5416397		18 kg			581 kg
15" 32" x 10.5" R16 5416401		20 kg			644 kg



NEW PRO ARMOR CRAWLER AT

- Directional tread for optimal performance
- Greater lug separation for easy mud clean out
- 8-ply, triple-belted ballistic sidewalls resist punctures

	TREAD DEPTH	TIRE WEIGHT	PLY RATING	SIDEWALL BELTS	LOAD RATING
15" 30" x 10" R15 5417534	FRONT/ REAR 18mm	16 kg	8	3	580 kg
15" 32" x 10" R15 5417535		18 kg			630 kg



WHAT CRAWLER ARE YOU?



XR

SINGLE DUROMETER

- Smaller lug height and single durometer gives this high-speed tire added rigidity and lateral stability when cornering
- Unique lug design excels in hard-pack, fast terrain

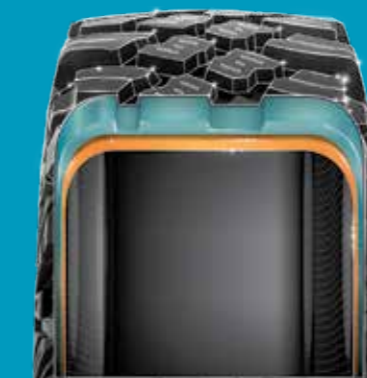

XG

DUAL-DUROMETER

- Taller lug height and dual-durometer construction
- Perfect balance between high-speed performance, durability and flex in order to grip slick rock



AT

DIRECTIONAL LUG PATTERN

- The same taller lug height as Crawler XG, providing more grip and better traction
- Wider lug spacing for excellent mud clean-out

WHAT PADDLE ARE YOU?



12 PADDLE

- 30" (Non-turbo RZR models)
- Fewer paddles for non-turbo/lower HP applications
- Perfect grip balance to maintain wheel speed



16 PADDLE

- 30" (Turbo RZR models)
- 32" (Turbo S and Velocity)
- Plenty of aggressive paddles for high HP vehicles
- Superior grip for wide-open sand riding



FRONT

REAR

PRO ARMOR SAND 12XT

- Unique 3-tier concave design on front tires
- Wider rear tires for more traction, plus better grip and flotation on the sand
- 12 paddles for optimized performance on non-Turbo models
- 28mm paddle depth specifically designed for increased traction, while limiting sand throw

		TREAD DEPTH	TIRE WEIGHT	PLY RATING	SIDEWALL BELTS	LOAD RATING
14"	30" x 11" R14 5415251	FRONT	12.8mm	10 kg	8	388 kg
14"	30" x 13" R14 5416949	REAR	28mm	11 kg	4	



WHEEL SIZE

14"



FRONT

REAR

PRO ARMOR SAND 16XT

- Unique 3-tier concave design on front tires
- Wider rear tires with additional paddles for more traction, better grip and flotation on the sand
- 16 paddles for optimized performance and traction on Turbo models
- 28mm paddle depth specifically designed for increased traction, while limiting sand throw

		TREAD DEPTH	TIRE WEIGHT	PLY RATING	SIDEWALL BELTS	LOAD RATING	
15"	30" x 11" R15 5416951	FRONT	13mm	10 kg	4	2	388 kg
15"	30" x 14" R15 5416953	REAR	28mm	15 kg			
15"	32" x 12" R15 5416952	FRONT	13mm	12 kg			463 kg
15"	32" x 15" R15 5416950	REAR	28mm	16 kg			



WHEEL SIZE

15"

TIRES



PRO ARMOR MUD XC

- Designed as the perfect mud-trail crossover for a smooth ride on the trail and aggressive traction in the mud
- Dual-compound technology with harder durometer lugs promote extended wear, increasing tire life
- 10-ply construction means added protection in the toughest terrain

		TREAD DEPTH	TIRE WEIGHT	PLY RATING	SIDEWALL BELTS	LOAD RATING
14"	27" x 9" R14 5416947	FRONT	14 kg			531 kg
14"	27" x 11" R14 5416948	REAR	14.5 kg	10	3	599 kg
14"	29" x 10" R14 5416946	FRONT/REAR	18 kg			41 kg



FRONT/REAR

WHEEL SIZE

14"



PRO ARMOR HD-K

- Designed to provide a smooth ride and aggressive traction in all riding terrains
- Triple-belted sidewall provides extreme protection and extends the tire life
- Quad belt tread core offers superior protection and longer tread life

		TREAD DEPTH	TIRE WEIGHT	PLY RATING	SIDEWALL BELTS	LOAD RATING	
14"	29" x 10" R14 5417507	FRONT/REAR	31.75mm	18 kg	10	3/1 Aramid	599 kg



FRONT/REAR

WHEEL SIZE

14"



PRO ARMOR MUD XT

- Aggressive traction in the mud
- Dual-compound technology with harder durometer lugs to promote extended wear and increase tire life
- 10-ply construction for added protection in the toughest terrain

		TREAD DEPTH	TIRE WEIGHT	PLY RATING	SIDEWALL BELTS	LOAD RATING	
15"	32" x 9" R15 5417530	FRONT/REAR	30mm	18 kg	10	3	599 kg



FRONT/REAR

WHEEL SIZE

15"



PRO ARMOR WHITEOUT

- Extra wide tires for flotation in snow
- Cross-hatched tread pattern designed for superior snow traction with limited digging
- 2-ply sidewall designed to balloon for maximum use of its 15" wide contact patch
- Stud compatible

		TREAD DEPTH	TIRE WEIGHT	PLY RATING	SIDEWALL BELTS	LOAD RATING	
14"	27" x 14" R14 5416032	FRONT	16mm	11 kg	8	2	424 kg
15"	30" x 15" R15 5416395	FRONT/REAR	17mm	21 kg	2		531 kg



FRONT/REAR

WHEEL SIZE

14"

15"



MORE SURFACE AREA FOR BETTER FLOTATION ON SNOW

Snow-specific tire for trails and deep powder. Features an extra wide, bias-ply construction that can run at low pressures for maximum flexibility. High-flotation performance maintains critical vehicle ground clearance in the snow.

WHEELS

COMMON

LIGHTING

CONNECTED TECHNOLOGY

AUDIO

WHEELS & TIRES

VEHICLE & RIDER PROTECTION

COOLERS

COCKPIT ACCESSORIES & MIRRORS

WINCHES

MISC. 570 & 700TH



16"

15"

14"

60-SERIES

A 6301 BEADLOCK
WEIGHT: 8.6 kg | **LOAD RATING:** 726 kg | **OFFSET:** +38
ACCENT: FRONT/REAR 16" x 7" 1523286
MATTE BLACK: FRONT/REAR 16" x 7" 1523285

50-SERIES

B 5101
WEIGHT: 6.6 kg | **LOAD RATING:** 363 kg | **OFFSET:** -5
MATTE BLACK: FRONT/REAR 15" x 10" 1523149-458

C 5201
WEIGHT: 7.8 kg | **LOAD RATING:** 590 kg | **OFFSET:** +4
ACCENT: FRONT/REAR 15" x 7" 1523184-266
MATTE BLACK: FRONT/REAR 15" x 7" 1523184-458

D 5202
WEIGHT: 8.1 kg | **LOAD RATING:** 590 kg | **OFFSET:** +4
ACCENT: FRONT/REAR 15" x 7" 1523102-266
MATTE BLACK: FRONT/REAR 15" x 7" 1523102-458

E 5203 BEADLOCK
WEIGHT: 7.3 kg | **LOAD RATING:** 590 kg | **OFFSET:** +38
MATTE BLACK: FRONT/REAR 15" x 7" 1522435-458

F 5204
WEIGHT: 6.1 kg | **LOAD RATING:** 590 kg | **OFFSET:** +55
MATTE BLACK: FRONT/REAR 15" x 7" 1522550-458

G 5205
FRONT WEIGHT: 6.8 kg | **LOAD RATING:** 408.2 kg | **OFFSET:** -4
REAR WEIGHT: 9.1 kg | **LOAD RATING:** 408.2 kg | **OFFSET:** -38
MATTE BLACK: FRONT 15" x 8" 1523727-458
REAR 15" x 10" 1523728-458

H 5206
WEIGHT: 6.1 kg | **LOAD RATING:** 590 kg | **OFFSET:** +55
MATTE BLACK: FRONT/REAR 15" x 7" 1524041
ONLY COMPATIBLE WITH PRO R 4, PRO R, TURBO R 4 & TURBO R

I 5207/5303
FRONT WEIGHT: 6.1 kg | **LOAD RATING:** 590 kg | **OFFSET:** -4
REAR WEIGHT: 6.1 kg | **LOAD RATING:** 590 kg | **OFFSET:** -38
MATTE BLACK: FRONT 15" x 8" 1524043
REAR 15" x 10" 1524042
ONLY COMPATIBLE WITH PRO R 4, PRO R, TURBO R 4 & TURBO R

J 5301 BEADLOCK
WEIGHT: 7.7 kg | **LOAD RATING:** 726 kg | **OFFSET:** +38
ACCENT: FRONT/REAR 15" x 7" 1523282
MATTE BLACK: FRONT/REAR 15" x 7" 1523266

K 5302 BEADLOCK
WEIGHT: 6.1 kg | **LOAD RATING:** 590 kg | **OFFSET:** +55
MATTE BLACK: FRONT/REAR 15" x 7" 1524038
ONLY COMPATIBLE WITH PRO R 4, PRO R, TURBO R 4 & TURBO R

5 WHEELS WITH 5 LUG NUTS. ONLY COMPATIBLE WITH PRO R 4, PRO R, TURBO R 4 & TURBO R.

40-SERIES

L 4201
FRONT WEIGHT: 5.9 kg | **LOAD RATING:** 408.2 kg | **OFFSET:** +4
REAR WEIGHT: 6.4 kg | **LOAD RATING:** 590 kg | **OFFSET:** -9
ACCENT: FRONT 14" x 7" 1522956-266
REAR 14" x 8" 1522957-266
MATTE BLACK: FRONT 14" x 7" 1522956-458
REAR 14" x 8" 1522957-458
NOT COMPATIBLE WITH XP 4 1000/1000 '18-22, XP 4 TURBO/TURBO '18-19

M 4202
FRONT WEIGHT: 5.8 kg | **LOAD RATING:** 408.2 kg | **OFFSET:** +4
REAR WEIGHT: 6.1 kg | **LOAD RATING:** 590 kg | **OFFSET:** -9
ACCENT: FRONT 14" x 7" 1522544-266
REAR 14" x 8" 1522545-266
MATTE BLACK: FRONT 14" x 7" 1522544-458
REAR 14" x 8" 1522545-458
NOT COMPATIBLE WITH XP 4 1000/1000 '18-22, XP 4 TURBO/TURBO '18-19

N 4203 BEADLOCK
FRONT WEIGHT: 5.9 kg | **LOAD RATING:** 408.2 kg | **OFFSET:** +4
REAR WEIGHT: 6.6 kg | **LOAD RATING:** 590 kg | **OFFSET:** -9
MATTE BLACK: FRONT 14" x 7" 1522238-458
REAR 14" x 8" 1522239-458

O 4204
FRONT WEIGHT: 5.9 kg | **LOAD RATING:** 408.2 kg | **OFFSET:** +4
REAR WEIGHT: 6.4 kg | **LOAD RATING:** 590 kg | **OFFSET:** -9
ACCENT: FRONT 14" x 7" 1522546-266
REAR 14" x 8" 1522547-266
MATTE BLACK: FRONT 14" x 7" 1522546-458
REAR 14" x 8" 1522547-458

P 4205
FRONT WEIGHT: 4.8 kg | **LOAD RATING:** 408.3 kg | **OFFSET:** +4
REAR WEIGHT: 5.7 kg | **LOAD RATING:** 590 kg | **OFFSET:** -9
MATTE BLACK: FRONT 14" x 7" 1521507-521
REAR 14" x 8" 1521508-521
LUSTER: FRONT 14" x 7" 1521507-410
REAR 14" x 8" 1521508-410

Q 4206
FRONT WEIGHT: 4.3 kg | **LOAD RATING:** 408.2 kg | **OFFSET:** +4
REAR WEIGHT: 4.9 kg | **LOAD RATING:** 590 kg | **OFFSET:** -9
MATTE BLACK: FRONT 14" x 6" 1522542-458
REAR 14" x 8" 1522543-458

R 4301 BEADLOCK
WEIGHT: 7.3 kg | **LOAD RATING:** 726 kg | **OFFSET:** +38
ACCENT: FRONT/REAR 14" x 7" 1523284
MATTE BLACK: FRONT/REAR 14" x 7" 1523283
NOT COMPATIBLE WITH XP 4 1000/1000 '18-22, XP 4 TURBO/TURBO '18-19

S 4302 BEADLOCK
WEIGHT: 18.1 kg | **LOAD RATING:** 725.7 kg | **OFFSET:** +58
MATTE BLACK: FRONT/REAR 14" x 7" 5418036

T 4303
WEIGHT: 18.1 kg | **LOAD RATING:** 725.7 kg | **OFFSET:** +58
MATTE BLACK: FRONT/REAR 14" x 7" 5418037

U HD DUAL BEADLOCK
WEIGHT: 18.1 kg | **LOAD RATING:** 725.7 kg | **OFFSET:** +28
MATTE BLACK: FRONT/REAR 14" x 7" 1524022-458

KNOW YOUR WHEELS

STEP 1: SELECT SERIES

- 4 = 40-SERIES
- 5 = 50-SERIES
- 6 = 60-SERIES

STEP 2: CHOOSE LOAD RATING

- 1 = <362.9 kg
- 2 = 363 - 589.7 kg
- 3 = 590 - 726+ kg

STEP 3: PICK STYLE

OFFSET / BEADLOCK / COLOR

INCREASE OFFSET FROM STOCK = NARROWER STANCE
DECREASE OFFSET FROM STOCK = WIDER STANCE

REPLACEMENT CAPS		POLARIS CAPS		PRO ARMOR CAPS	
LUSTER	ALL WHEELS EXCEPT 5204 & 5203 BEADLOCK	1521509-410	LUSTER	ALL WHEELS EXCEPT 5204 & 5203 BEADLOCK	5453209-410
MATTE BLACK		1521509-521	MATTE BLACK		5453209-458
LUSTER	5203 BEADLOCK	1522243-410	MATTE BLACK	5204	1523063-458
MATTE BLACK		1522243-458	LUSTER	5203 BEADLOCK	1523015-410
HD MATTE BLACK	ALL WHEELS	5457498-458	MATTE BLACK		1523015-458

LUG NUTS		LUG NUTS REQUIRED	
12mm x 1.5 SPLINED LUG NUTS		.95 cm - 24 HEX LUG NUTS	
16 LUG NUTS WITH WRENCH	TRAIL S '21-22, TRAIL '21-22, TURBO S '18-21, XP TURBO '19-21, TURBO S 4 '20-21, XP 4 TURBO '19-21	2879332	16 HEX LUG NUTS
4 LUG NUTS WITHOUT WRENCH	XP 4 1000 '14-22, XP 1000 '14-22, S 900 '15-20, S 4 1000 '19-20, S 1000 '16-20, PRO XP '21-22, 900 '14-20	2879331	570 '13-22
SPLINED LUG WRENCH	TRAIL S '21-22, TRAIL '21-22, TURBO S '18-21, XP TURBO '19-21, TURBO S 4 '20-21, XP 4 TURBO '19-21, XP 4 1000 '14-22, XP 1000 '14-22, S 900 '15-20, S 4 1000 '19-20, S 1000 '16-20, R51 '18-22, PRO XP '21-22, 900 '14-20	2204966	4 HEX LUG NUTS

FORGED BEADLOCK RINGS		BEADLOCK REQUIRED	
14" BEADLOCK RINGS		15" BEADLOCK RINGS	
4203 BEADLOCK & HD DUAL BEADLOCK (INCLUDES BOLTS) MACHINED: 1522244-266		5203 BEADLOCK (INCLUDES BOLTS) MACHINED: 1522240-266	
4301 BEADLOCK REPLACEMENT & HD DUAL BEADLOCK MATTE BLACK: 1523146-458		5301 BEADLOCK REPLACEMENT MATTE BLACK: 1523147-458	

KNOW YOUR TERRAIN



- Tread patterns optimized for extreme traction
- Ideal for both hard-pack and loose trail



- Flexible "grippy" tread
- Aggressive side bite



- Provides traction and durability
- Built to perform in hard sand, jagged rocks or any other extreme terrain



- Extra deep treads
- Self-cleaning lugs



- Paddles provide traction and durability in soft sand
- Built to float on top of sand



- Triple-belted sidewalls to resist puncture
- Purpose-built, long lasting tread patterns



- Handles extreme cold
- Holds shape and provides traction

14" 40-SERIES

BACKCOUNTRY/TRAIL

MUD

DESERT/ROCK

SAND

	DUAL-THREAT 26"	DUAL-THREAT 29"	ATTACK 26"	MUD XC 27"	MUD XC 29"		CRAWLER XG 30"	CRAWLER XG 32"	CRAWLER XR 28"	SAND 12XT 30"
4201 Accent	2883138	2883146	2882390	2884272	2884265		2882396	2882452	2882394	
4201 Matte Black	2883139	2883147	2882391	2884273	2884266		2882397	2882451	2882395	
4202 Accent	2883140	2883148	2881335	2884267	2884260		2881560	2882448	2881343	
4202 Matte Black	2883141	2883149	2881336	2884268	2884261		2881561	2882447	2881344	
4203 BEADLOCK Matte Black BEADLOCKS SOLD SEPARATELY			2881381					2881382	2881386	
4204 Accent	2883142	2883150	2881347	2884270	2884263		2881558	2882450	2881355	
4204 Matte Black	2883143	2883151	2881348	2884271	2884264		2881559	2882449	2881356	2884034
4205 Luster			2881359				2881564		2881371	
4205 Matte Black	2883144	2883152	2881360	2884269	2884262		2881563	2882453	2881372	
4206 Matte Black	2883145	2883153	2881404							
4301 BEADLOCK Accent BEADLOCKS PRE-MOUNTED	2883217	2883219					2883211	2883215	2883213	
4301 BEADLOCK Matte Black BEADLOCKS PRE-MOUNTED	2883216	2883218					2883210	2883214	2883212	
NEW 4302 BEADLOCK Matte Black BEADLOCKS PRE-MOUNTED	2889550	2889551	2889549	2889552	2889553		2889555	2889556	2889554	
NEW 4303 Matte Black	2889542	2889543	2889541	2889544	2889545		2889547	2889548	2889546	

15" 50-SERIES

BACKCOUNTRY/TRAIL

MUD

DESERT/ROCK

15"

SNOW

15"

SAND

	DUAL-THREAT 32"	ATTACK 2.0 28"	ATTACK 2.0 30"	MUD XT 32"	PRO RUNNER 30"	PRO RUNNER 32"	PRO RUNNER 33"	CRAWLER XG 28"	CRAWLER XG 30"	CRAWLER XR 32"	CRAWLER XR 33"	NEW CRAWLER AT 30"	NEW CRAWLER AT 32"	5101 Matte Black	WHITEOUT 30"	5205 Matte Black	SAND 16XT 30"	SAND 16XT 32"
5201 Accent	2883694	2883160	2883169				2883188		2883179	2883194	2884744	2889510	2889518		2883172		2884035	2884036
5201 Matte Black	2883693	2883159	2883168				2883187		2883178	2883193	2884736	2889511	2889519			NEW 5207/5303 Matte Black		2885020
5202 Accent	2883696	2883158	2883167	2885052	2885024	2885031	2885038	2883186	2883177	2883192	2884737	2889512	2889520					
5202 Matte Black	2883695	2883157	2883166	2885053	2885025	2885032	2885039	2883185	2883176	2883191	2884738	2889513	2889521					
5203 BEADLOCK Matte Black BEADLOCKS SOLD SEPARATELY	2883699	2883154	2883163	2885056	2885028	2885035	2885042	2883182	2883173	2882444	2884741	2889516	2889524					
5204 Matte Black	2883700	2883155	2883164	2885058	2885030	2885037	2885044	2883183	2883174	2882445	2884743	2889517	2889525					
NEW 5206 Matte Black	2885015			2885019		2885017	2885018			2885016	2885014							
5301 BEADLOCK Accent BEADLOCKS PRE-MOUNTED	2883698	2883162	2883171	2885054	2885026	2885033	2885040	2883190	2883181	2883196	2884739	2889514	2889522					
5301 BEADLOCK Matte Black BEADLOCKS PRE-MOUNTED	2883697	2883161	2883170	2885055	2885027	2885034	2885041	2883189	2883180	2883195	2884740	2889515	2889523					
NEW 5302 BEADLOCK Matte Black	2885009			2885013		2885011	2885012			2885010	2885008							

16" 60-SERIES

ROCK/RACE



6301 BEADLOCK Accent BEADLOCKS PRE-MOUNTED	2883703
6301 BEADLOCK Matte Black BEADLOCKS PRE-MOUNTED	2883702

2 WAYS TO PURCHASE INDIVIDUAL WHEELS & TIRES - OR - COMPLETE SETS AS LISTED

Exclusively at Polaris Authorized Dealers

WHEEL & TIRE SETS

VALVES



COLBY SHORT ULTIMATE VALVE (2 PACK)

» 2883292



COLBY EMERGENCY VALVE (2 PACK)

» 2883293



COLBY COMBO VALVE KIT (16 PACK)

• Includes eight ultimate valves and eight emergency valves

» 2883294

TURBO S '19-21, XP TURBO '19-21, TURBO S 4 '20-21, XP 4 TURBO '19-21, XP 4 1000 '14-22, XP 1000 '14-22, S 900 '15-20, S 4 1000 '19-20, S 1000 '16-20, PRO XP '21-22, 900 '14-20

PERFORMANCE



FRONT SWAY BAR KIT

» 2881205-458

XP TURBO '15-21, XP 4 TURBO '16-21, XP 4 1000 '16-22, XP 1000 '16-22
NOT COMPATIBLE WITH HIGH CLEARANCE A-ARMS

- ⊙ LUG NUTS REQUIRED. SEE PREVIOUS PAGE FOR CAPS, BEADLOCK RINGS AND LUG NUTS.
- ⊕ WHEELS WITH 5 LUG NUTS. ONLY COMPATIBLE WITH PRO R 4, PRO R, TURBO R 4 & TURBO R.

COMMON

LIGHTING

CONNECTED TECHNOLOGY

AUDIO

WHEELS & TIRES

VEHICLE & RIDER PROTECTION

COOLERS

COCKPIT ACCESSORIES & MIRRORS

WINCHES

MISC. STOR. & YOUTH

> VEHICLE & RIDER PROTECTION

WHEN PUSHING LIMITS

in punishing off-road environments, keep your RZR protected from harsh hits and damage with an added layer of protection and peace of mind.

HMW FRONT ARM GUARDS

» 2880274

TRAIL S '21-22, TRAIL '21-22, S 900 '15-20,
S 4 1000 '19-20, S 1000 '16-20, 900 '15-20

» 2880170

900 '14-20

» 2879454

XP TURBO '15-21, XP 4 TURBO '16-21,
XP 4 1000 '14-22, XP 1000 '14-22

TOUGH .91 cm THICK
DESIGN WITHSTANDS THE
TOUGHEST IMPACTS

HMW SKID PLATE

» 2-SEAT • 2880290

TRAIL S '21-22, TRAIL '21-22, S 900 '15-20,
S 1000 '16-20, 900 '14-20

**CUSTOM CONTOURED FOR A PERFECT
FIT TO RETAIN MAXIMUM
GROUND CLEARANCE**

HMW REAR GUARDS

» 2880172

TRAIL '21-22, 900 '14-20



FULL COVERAGE FENDER FLARES

- Keep the mud, dirt and debris from launching off the tires and into your face
- Includes two, front only

» 2881985

TRAIL S '21-22, TRAIL '21-22, TURBO S '18-21, TURBO S 4 '19-21,
XP TURBO '15-21, XP 4 TURBO '16-21, XP 1000 '14-22, XP 4 1000 '14-22,
S 900 '15-20, S 4 1000 '19-20, S 1000 '16-20, 900 '14-20



MUD FLAPS

- Keeps the front wheels from flipping mud into the cab
- Rigid, injection-molded design to eliminate warping in high-heat conditions
- Designed to specifically integrate into front fender flares
- Includes two, front only

» 2879938

TURBO S '19-21, TURBO S 4 '19-21, XP TURBO '15-21, XP 4 TURBO '16-21,
XP 1000 '14-22, XP 4 1000 '14-22, S 900 '15-20, S 4 1000 '19-20, S 1000 '16-20, 900
'14-20



152.4 cm STYLE FENDER FLARES

- Stock replacement for Trail S
- Includes four, front and rear

» 2879434

TRAIL S '21-22, TRAIL '21-22, 900 '14-20



INTRUSION BAR

» 2879181

S 900 '15-20, S 4 1000 '19-20, S 1000 '16-20, 900 '14-20
NOT COMPATIBLE WITH FULL WINDSHIELDS
NOT COMPATIBLE WITH LED UNDER ROOF LIGHT
BAR MOUNT (2881203, 2881553)

KEEP IT
ICE COLD



GRIZZLY TESTED.

POLARIS APPROVED.



This cooler is IGBC-approved, meaning it withstands the power expended by a typical grizzly bear if it was trying to get inside.

Seriously, there are experts who know what a grizzly is capable of doing, and they certify our coolers can take it.



28, 57 & 99
LITER FEATURES



ComfortCarry Handles



TravelLock System



EasyOut Drain System



NoSlip Rubber Feet



PolarWall Insulation



IceLock Seal

POLARIS NORTHSTAR COOLERS CAN SURVIVE JUST ABOUT ANYTHING - FROM EXTREME HEAT TO A NASTY TUMBLE OFF A VEHICLE.



99 LITER

- » GRAPHITE • 2883426
- » DESERT • 2883392



57 LITER

- » GRAPHITE • 2883425
- » DESERT • 2881259



28 LITER

- » GRAPHITE • 2883424
- » DESERT • 2881315



14 LITER

- » GRAPHITE • 2883968



19 LITER SOFT-SIDED COOLER

- » GRAPHITE • 2889285

ESSENTIAL ACCESSORIES SO YOUR COOLER WORKS AS HARD AS YOU DO

COOLER ACCESSORIES	99 LITER	57 LITER	28 LITER	DON'T FORGET THESE ACCESSORIES	
<p>WIRE BASKET</p>	2883648	2882185	2882438	<p>887 mL</p> <p>TUMBLERS</p> <ul style="list-style-type: none"> » 887 mL • 2883394 » 591 mL • 2883393 	<p>LOCK & RIDE 28 L COOLER BRACKET</p> <ul style="list-style-type: none"> » 2884070 TURBO R 4 '22, TURBO R '22, PRO XP 4 '20-22, PRO XP '20-22 » N-W 2889200 PRO R 4 '22, PRO R '22
<p>DIVIDERS Doubles as cutting board</p>	2883468 COMES WITH ONE DIVIDER	2882184 COMES WITH TWO DIVIDERS	2882186 COMES WITH ONE DIVIDER		
<p>SEAT CUSHION</p>	NOT AVAILABLE	2882179	2882507		
<p>WHEELS</p>	2883967	2882180	NOT AVAILABLE		

> COCKPIT ACCESSORIES



HARNESSES

Not available in Europe



CLICK-6 HARNESS TOP SELLER

- Racing-quality, premium construction for the greatest security and protection
- Six straps hold a driver securely in place in all riding conditions
- One-click, quick-release buckle releases straps, allowing easy egress
- Fully adjustable to fit riders of all sizes
- Easy to buckle and adjust, even while wearing helmet and gloves

DRIVER SIDE

» 2882244

TRAIL S '21-22, TRAIL '21-22, TURBO S '18-21, XP TURBO '19-21, TURBO S 4 '20-21, XP 4 TURBO '21, XP 1000 '14-22, S 900 '15-20, S 4 1000 '20, S 1000 '16-20, 900 '14-20

DOES NOT FIT 4 SEAT MODELS OR HIGHLIFTER MODEL

» 2884075

PRO R '22, TURBO R '22, PRO XP '20-22

» 2884077

PRO R 4 '22, TURBO R 4 '22, PRO XP 4 '20-22

PASSENGER SIDE

» 2882245

TRAIL S '21-22, TRAIL '21-22, TURBO S '18-21, XP TURBO '19-21, TURBO S 4 '20-21, XP 4 TURBO '21, XP 1000 '14-22, S 900 '15-20, S 4 1000 '20, S 1000 '16-20, 900 '14-20

DOES NOT FIT 4 SEAT MODELS OR HIGHLIFTER MODEL

» 2884076

PRO R '22, TURBO R '22, PRO XP '20-22

» 2884078

PRO R 4 '22, TURBO R 4 '22, PRO XP 4 '20-22

REAR PASSENGER

» 2884079

PRO R 4 '22, TURBO R 4 '22, PRO XP 4 '20-22



RZR SUBZERO 4-PT HARNESS TOP SELLER

» DRIVER SIDE

2882281

TRAIL S '21-22, TRAIL '21-22, TURBO S '18-21, XP TURBO '15-21, XP 1000 '14-22, TURBO S 4 '19-21, XP 4 TURBO '15-21, XP 4 1000 '14-22, S 900 '15-20, S 4 1000 '19-20, S 1000 '16-20, 900 '14-20, PRO XP 4 '20-22, PRO XP 4 '20-22

» PASSENGER SIDE

2882282

TRAIL S '21-22, TRAIL '21-22, TURBO S '18-21, XP TURBO '15-21, XP 1000 '14-22, TURBO S 4 '19-21, XP 4 TURBO '15-21, XP 4 1000 '14-22, S 900 '15-20, S 4 1000 '19-20, S 1000 '16-20, 900 '14-20, PRO XP 4 '20-22, PRO XP 4 '20-22

MIRRORS



NEW ADJUSTABLE FOLDING SIDE MIRRORS

- Left and right mirrors included
- Installs in minutes and integrates into a designated mounting position
- Laminated safety glass for excellent scratch resistance

» 2884524

TRAIL S '21-22, TRAIL '21-22, TURBO S '18-21, XP TURBO '19-21, XP 1000 '14-22, TURBO S 4 '20-21, XP 4 TURBO '19-21, XP 4 1000 '14-22, S 900 '15-20, S 4 1000 '19-20, S 1000 '16-20, 900 '14-20



PREMIUM CONVEX REARVIEW MIRROR TOP SELLER

- Installs in minutes and integrates into a designated mounting position
- Laminated safety glass for excellent scratch resistance

» 2883763

PRO R 4 '22, PRO R '22, TURBO R 4 '22, TURBO R '22, TRAIL S '21-22, TRAIL '21-22, PRO XP 4 '20-22, PRO XP '20-22



CONVEX DESIGN DELIVERS WIDE REAR VIEW

REARVIEW MIRROR TOP SELLER

- Works with all roofs, soft tops and windshields

» 2877945

TURBO S '18-21, XP TURBO '15-21, XP 1000 '14-22, TURBO S 4 '19-21, XP 4 TURBO '15-21, XP 4 1000 '14-22, S 900 '15-20, S 4 1000 '19-20, S 1000 '16-20, 900 '14-20



SCRATCH-RESISTANT GLASS MIRROR LENS

CONVEX REARVIEW MIRROR TOP SELLER

- Bolts into your choice of pre-designated mounting locations on the vehicle frame for easy install
- Convex design provides broad, expanded view of what's behind or alongside the vehicle

» 2881540

TURBO S '18-21, XP TURBO '15-21, XP 1000 '14-22, TURBO S 4 '19-21, XP 4 TURBO '15-21, XP 4 1000 '14-22, S 900 '15-20, S 4 1000 '19-20, S 1000 '16-20, 900 '14-20



QUICK GLANCE, WIDE-ANGLE VIEWING FOR MAXIMUM VISIBILITY

WIDE-ANGLE REARVIEW MIRROR

- Stamped steel frame and backing plate with large 6.4 cm x 35.6 cm convex mirror
- Up to 10° of range to adjust for rider height or view preference
- Easy over-structure installation with stamped steel mounts

» 2881199

TURBO S '18-21, XP TURBO '15-21, XP 1000 '14-22, TURBO S 4 '19-21, XP 4 TURBO '15-21, XP 4 1000 '14-22, S 900 '15-20, S 4 1000 '19-20, S 1000 '16-20, 900 '14-20

MISC

SEAT SLIDER

» 2879460

TURBO S '18-21, XP TURBO '15-21, XP 1000 '14-22, TURBO S 4 '19-21, XP 4 TURBO '15-21, XP 4 1000 '14-22, S 900 '15-20, S 4 1000 '19-20, S 1000 '16-20, 900 '14-20

SWITCH PANEL

- Adds five spaces for rocker switches without blocking storage

» 2881987

TURBO S '18-21, XP TURBO '15-21, XP 1000 '14-22, TURBO S 4 '19-21, XP 4 TURBO '15-21, XP 4 1000 '14-22, S 900 '15-20, S 4 1000 '19-20, S 1000 '16-20, 900 '14-20

COMMON

LIGHTING

CONNECTED TECHNOLOGY

AUDIO

WHEELS & TIRES

VEHICLE & RIDER PROTECTION

COOLERS

COCKPIT ACCESSORIES & MIRRORS

WINCHES

MISC. 570 & YOUTH

85

84



> WINCHES

DEPENDABLE. TOUGH. BUILT FOR THE OFF-ROAD.

A Polaris Engineered winch is designed to help you get the job done right, get you on your way faster and prepare you for the unexpected.

WHY POLARIS?

Polaris off-road vehicles are engineered with designated mounting points and wiring for seamless install of Polaris Engineered winches.



TESTED **1,200+** PULLS AT MAX LOAD



BUILT TO WITHSTAND **-29° C** TEMPERATURES



OPERATES FULLY SUBMERGED



MILITARY TESTED & APPROVED

UPGRADE YOUR CONTROLS

WIRED REMOTE CONTROL

• Must order remote handle and socket together

» REMOTE HANDLE 4013466 <small>WORKS WITH 2882240, 2883828, 2883825</small>	» SOCKET 4017102 <small>WORKS WITH 2883825</small>	» SOCKET 4014228 <small>WORKS WITH 2882240, 2883828</small>
---	--	---

REPLACEMENT PARTS

15 M STEEL CABLE	15 M SYNTHETIC ROPE	
1,588 kg SERIES » 2878890	1,588 kg SERIES » 2878888	2,041 kg SERIES » 2879187

FEATURES & BENEFITS

ALL POLARIS ENGINEERED WINCHES COME WITH:

- ✓ INTEGRATED WIRING, MOUNT, PREASSEMBLED
- ✓ HOOK WITH STRAP
- ✓ CUT STEEL GEARS & SEALED DRIVETRAIN
- ✓ SEALED PERMANENT MAGNET MOTOR

<p>Retrieve cable 5x as fast as standard mode on other Polaris winches. Get back to riding or complete your task quicker.</p> <ol style="list-style-type: none"> Set winch dial to N (Neutral) to manually pull the rope out and secure the hook to your anchor point. Set winch dial to L (Low) for maximum pulling power while winching your load. Set winch dial to H (High) for retrieving the rope 5x faster with Rapid Rope Recovery. 	✓	✓	NOT AVAILABLE
<p>Auto Stop technology protects and extends the life of your winch by automatically stopping the winch at the end of pull to prevent over-spooling. While plowing, it prevents the plow frame from bending by stopping the winch once the plow has been lifted.</p>	✓	✓	<p>ADD AUTO STOP UPGRADE 2881693 <small>SYNTHETIC ROPE REQUIRED</small></p>
<p>With its lightweight, yet extremely strong, design and superior flexibility, this 15 m long synthetic rope is easy to handle and can stand up to any tough job.</p>	✓	✓	<p>ADD SYNTHETIC ROPE 2878888</p>
<p>This convenient remote operates your Polaris winch wirelessly from within 15 m of the vehicle. Operate your winch safely outside your vehicle while on the job site or trails.</p>	✓	✓	<p>ADD WIRELESS REMOTE 2879316</p>

MODEL	2,721 kg	2,041 kg	1,588 kg	REQUIRED CABLES
PRO R 4 / PRO R '22 TURBO R 4 / TURBO R '22 <small>Includes both wired and wireless remote</small>	NEW 2884341	NEW 2884340		INCLUDED WITH WINCH
TRAIL S '21-22 TRAIL '21-22		2885126	2885127	CABLES INCLUDED WITH WINCH WINCH COVER KIT REQUIRED 2884118
PRO XP 4 / PRO XP '20-22 <small>Includes both wired and wireless remote</small>	2883759	2883758		INCLUDED WITH WINCH
XP 1000 '14-22, XP 4 1000 '14-22 XP TURBO '19-21, XP 4 TURBO '15-21 S 900 '15-20, S 900 '14-20 S 4 1000 '19-20, S 1000 '16-20		TOP SELLER 2882240	TOP SELLER 2881671	2884118 TURBO S/4 '18-21, XP TURBO/4 '19-21, XP 1000/4 '19-22 2881551 S 900 '16-20, S 1000 '16-20, 900 '15-20 2881646 S 4 1000 '19-20
TURBO S 4 '19-21 TURBO S '18-21		2883828		INCLUDED WITH WINCH
RS1 '18-22		2883825 <small>EXTREME BUMPER (2883783-458) REQUIRED, SOLD SEPARATELY</small>		INCLUDED WITH WINCH

PRO PRO HEAVY DUTY SERIES TOP-OF-THE-LINE FEATURES BEST FOR PLOWING, HEAVY-DUTY OUTDOOR CHORES & TRAIL RIDING



HD HEAVY DUTY SERIES BUILT FOR THE OFF-ROAD BEST FOR THE CASUAL OFF-ROAD RIDER



PRO PRO HEAVY DUTY SERIES

HD HEAVY DUTY SERIES

COMMON

LIGHTING

CONNECTED TECHNOLOGY

AUDIO

WHEELS & TIRES

VEHICLE & RIDER PROTECTION

COOLERS

COCKPIT ACCESSORIES & MIRRORS

WINCHES

MISC. STU & YOUTH

87

86

> ADDITIONAL ACCESSORIES

MISC

FIRE EXTINGUISHER MOUNT

» 2881200

PRO R 4 '22, PRO R '22, TURBO R 4 '22, TURBO R '22, PRO XP 4 '20-22, PRO XP '20-22 TRAIL S '21-22, TRAIL '21-22, TURBO S '18-21, XP TURBO '15-21, XP 1000 '14-22, TURBO S 4 '19-21, XP 4 TURBO '15-21, XP 4 1000 '14-22, S 900 '15-20, S 4 1000 '19-20, S 1000 '16-20, 900 '14-20



LOCK & RIDE RZR WHIP FLAG & POLE

» FLAG & POLE • 2881468

» MOUNT • 2877502

PRO R 4 '22, PRO R '22, TURBO R 4 '22, TURBO R '22, PRO XP 4 '20-22, PRO XP '20-22, TRAIL S '21-22, TRAIL '21-22, TURBO S '18-21, XP TURBO '15-21, XP 1000 '14-22, TURBO S 4 '19-21, XP 4 TURBO '15-21, XP 4 1000 '14-22, S 900 '15-20, S 4 1000 '19-20, S 1000 '16-20, 900 '14-20



RIDE & REPAIR ESSENTIALS KIT

» 2881207

PRO R 4 '22, PRO R '22, TURBO R 4 '22, TURBO R '22, PRO XP 4 '20-22, PRO XP '20-22, TRAIL S '21-22, TRAIL '21-22, TURBO S '18-21, XP TURBO '15-21, XP 1000 '14-22, TURBO S 4 '19-21, XP 4 TURBO '15-21, XP 4 1000 '14-22, S 900 '15-20, S 4 1000 '19-20, S 1000 '16-20, 900 '14-20

PREMIUM FILTER KIT TOP SELLER

- Polaris Ultraweb high performance air filter
- Provides superior engine protection with 99.99% efficiency
- Superior dust-holding capacity
- Lower restriction offers better performance for high horsepower, torque and acceleration

» 2882233

S 900 '15-20, S 4 1000 '19-20, S 1000 '16-20, 900 '14-20

» 2882234

TURBO S '18-21, XP TURBO '19-21, TURBO S 4 '20-21, XP 4 TURBO '19-21, XP 4 1000 '14-22, XP 1000 '14-22, PRO XP '21-22

570

LOCK & RIDE SPORT ROOF

» BLACK • 2878748
570 '12-22

LOCK & RIDE POLY REAR PANEL

» 2878752
570 '12-22

REAR BUMPER

» 2878697
570 '12-22

LOCK & RIDE FULL WINDSHIELD - POLY

» 2879492
570 '12-22

HALF WINDSHIELD - POLY

» 2879493
570 '12-22

FRONT BUMPER

» 2878284
570 '12-22

POLARIS HD 1,588 kg WINCH

- All power cables included in the kit

» 2879334
570 '12-22

BUS BAR HARNESS REQUIRED, SOLD SEPARATELY

SEAT ADJUSTER KIT

» 2877390
570 '12-22

HORN KIT

» 2877788
570 '12-22



LOCK & RIDE CARGO BOX

- Holds and protects gear
- Attaches to the rear cargo bed in 10 seconds
- Rubber gasket seal to keep dirt and moisture out
- Lockable latches, heavy duty hinges, side handles

» 2876439-070
570 '12-22

> YOUTH



200 EFI



NEW LOCK & RIDE FULL WINDSHIELD

- Made of durable polycarbonate to protect the cab from debris, dust, rain and wind
- Lock & Ride offers easy, toolless installation
- Integrates with the roof to prevent rain from entering the cab

» 2884570
200 EFI '22



NEW LOCK & RIDE HALF WINDSHIELD

- Made of durable polycarbonate to protect the cab from debris, dust, rain and wind
- Lock & Ride offers easy, toolless installation
- Fully seals at the base for lower protection from the elements, while the open top-half enables airflow

» 2884571
200 EFI '22



NEW POLY ROOF

- Durable HDPE material provides protection from the weather
- 4-bolt installation
- Integrates with full windshield to provide complete cab coverage

» 2884572
200 EFI '22



NEW BUMPERS

- Made of durable steel to provide great protection
- Chassis integrated mounting
- Front bumper offers integrated tow hook

» FRONT • 2884577
200 EFI '22

» REAR • 2885144
200 EFI '22



NEW ROCK SLIDERS

- Add durable protection from rocks, stumps or other debris with steel rock sliders
- Chassis integrated mounting for easy install
- Comes with two steel rock sliders

» 2885146
200 EFI '22



NEW REAR STORAGE BAG

- 3 L storage capacity
- Mounts to rear ROPS with a Velcro wrap
- Made to withstand the elements and wear with durable ballistic nylon construction

» 2885145
200 EFI '22

NEW PRO ARMOR YOUTH CRAWLER TIRE

- 25" design provides additional ground clearance
- Improved performance in all types of applications, from rock crawling to desert running
- Triple-belted sidewall for additional puncture-resistance

» FRONT/REAR • 25" x 9.5" R12 • 5417953
200 EFI '22

TREAD DEPTH	TIRE WEIGHT	PLY RATING	SIDEWALL BELTS	LOAD RATING
13mm	10.5 kgs	8	3	437 kgs

NEW PRO ARMOR YOUTH COMBAT WHEEL

- Designed specifically for youth vehicles
- Increased strength and lightweight performance helps overcome obstacles on the trail
- Compatible with stock lug nuts

» FRONT • 12" x 7" • 1525222
200 EFI '22

» REAR • 12" x 7" • 1525223
200 EFI '22

NEW PRO ARMOR WHEEL & TIRE SET: COMBAT & YOUTH CRAWLER

- Compatible with stock lug nuts

» FOUR WHEELS & TIRES • 2889410
200 EFI '22

COMMON

LIGHTING

CONNECTED TECHNOLOGY

AUDIO

WHEELS & TIRES

VEHICLE & RIDER PROTECTION

COOLERS

COCKPIT ACCESSORIES & MIRRORS

WINCHES

MISC. 570 & YOUTH

FOR THE LIFE OF YOUR RIDE

PARTS THAT PUSH THE LIMITS WITHOUT SACRIFICING STRENGTH AND DURABILITY.

We build our products so anyone with the right tools can maintain their vehicle.

POLARIS

ENGINEERED PARTS & LUBRICANTS

PARTS & GARAGE

MAINTENANCE

OIL & LUBRICANTS

MAINTENANCE FLUIDS

BATTERIES & GARAGE ACCESSORIES

HO PARTS

SERVICE PARTS

TIRE SEALANT & TRAILERING

POLARIS POWER

91

MAINTENANCE TIP

BREAK-IN PERIOD

The break-in period for your new RZR is the first 25 hours of operation, 1 month, or the time it takes to use the first two tanks of fuel (whichever comes first). No single action on your part is as important as a proper break-in period. Careful treatment of a new engine will result in more efficient performance and longer life for the engine.

AIR FILTER

A clogged air filter can restrict air flow to the engine leading to reduced engine performance, engine life or catastrophic failure.

BRAKE PADS

Maintaining and/or replacing brakes are critical to the safety and functionality of a vehicle. Brake pads should be checked for wear and oil or grease (petroleum products) contamination and brake discs should be checked for cracks, excessive corrosion or warping.

HALF SHAFT

Check for tears and punctures in the boot, which can lead to CV joint wear that can contribute to axle failure.

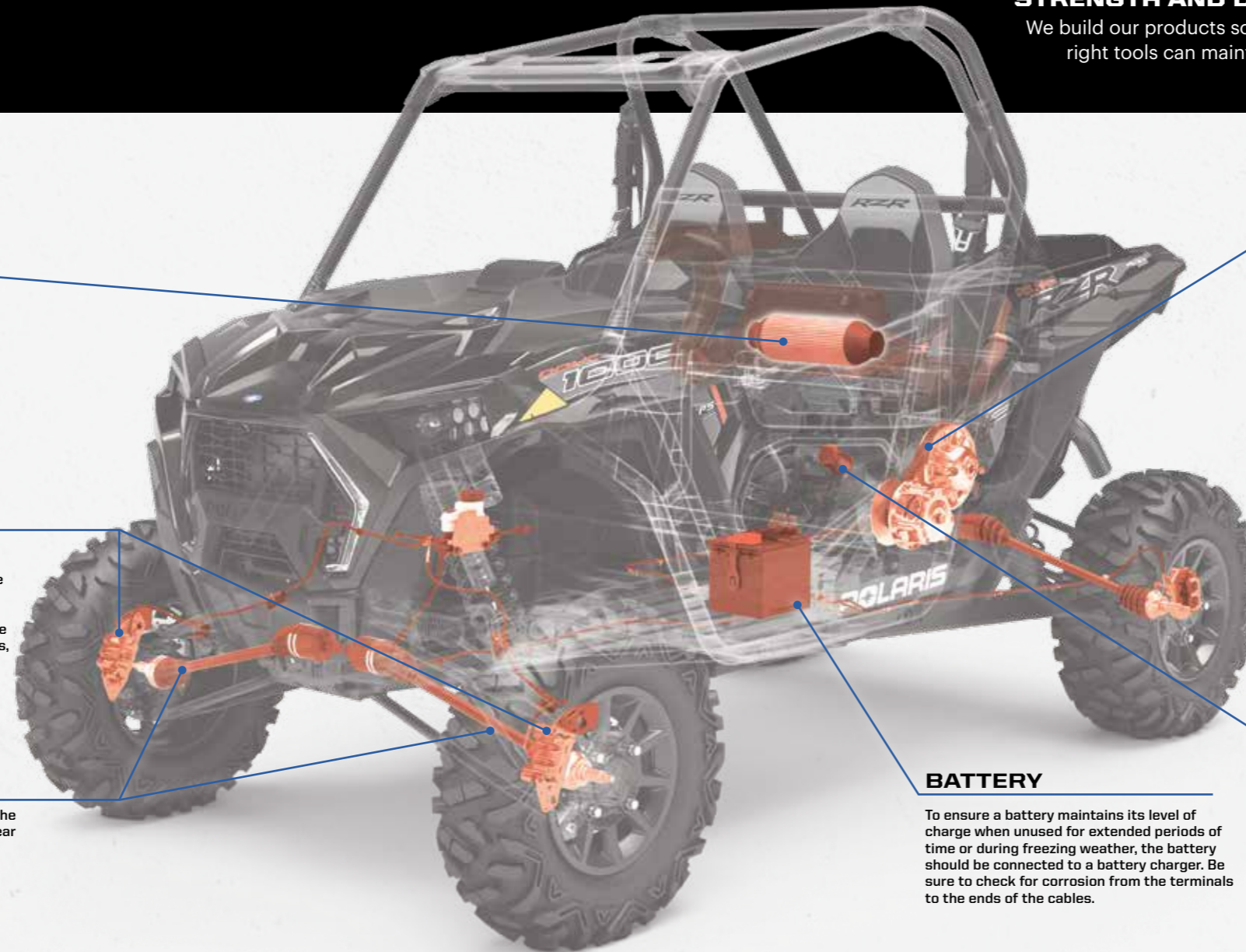

DRIVE BELT

Polaris Engineered belts deliver unmatched performance for your off-road vehicle. Developed and tested on all our engines for all environments and conditions. Check your belt for delamination, hour glassing and glazing.

BREAK-IN PERIOD

- Use lower gear (if available) while varying speeds and avoid wide open throttle for 8-16 km
- If no low gear is available, vary at moderate speeds while avoiding wide open throttle for 80 km

OUR INVESTMENT

- 32,187 km of field testing
- Thousands of dyno hours
- 18+ months of development (13,000+ design hours) per belt
- 1,500+ vehicle validation hours
- Collaboration with powertrain and clutch engineers

YOUR ADVANTAGE

- No clutch recalibration
- Less wear and tear due to heat
- Ensure maximum vehicle performance
- More time riding, less time wrenching
- Produced in collaboration with powertrain and clutch engineers to ensure a perfect fit, maximum performance and ultimate durability

BATTERY

To ensure a battery maintains its level of charge when unused for extended periods of time or during freezing weather, the battery should be connected to a battery charger. Be sure to check for corrosion from the terminals to the ends of the cables.

OIL FILTER

Change oil filters with every oil change to provide the best engine protection and keep the engine operating at peak performance.

FOLLOW RECOMMENDED SERVICE INTERVALS IN THE OWNER'S MANUAL

MAINTENANCE SCHEDULE

25 HRS / 400 km

BREAK-IN MAINTENANCE

ENGINE OIL & OIL FILTER
CHANGE

GENERAL LUBRICATION
ALL FITTINGS, PIVOTS, CABLES, ETC.

AIR FILTER
INSPECT
REPLACE AS NEEDED

50 HRS / 800 km

6 MONTHS

AIR FILTER
INSPECT
REPLACE AS NEEDED

GENERAL LUBRICATION
ALL FITTINGS, PIVOTS, CABLES, ETC.

DRIVE BELT
INSPECT & ADJUST
REPLACE AS NEEDED

100 HRS / 1,600 km

12 MONTHS

ENGINE OIL & OIL FILTER
CHANGE

DRIVE BELT
INSPECT & CLEAN
REPLACE AS NEEDED

TRANSMISSION FLUID
CHANGE

AIR FILTER
INSPECT
REPLACE AS NEEDED

150 HRS / 2,400 km

18 MONTHS

BATTERY
TEST & CLEAN
REPLACE AS NEEDED

DRIVE BELT
INSPECT & CLEAN
REPLACE AS NEEDED

TIRES
INSPECT CONDITION & PRESSURE

AIR FILTER
INSPECT
REPLACE AS NEEDED

200 HRS / 3,200 km

24 MONTHS

ENGINE OIL & OIL FILTER
CHANGE

BRAKE PADS & FLUID
REPLACE BRAKE FLUID

SPARK PLUGS
INSPECT
REPLACE AS NEEDED

AIR FILTER
INSPECT
REPLACE AS NEEDED

250 HRS / 4,023 km

30 MONTHS

BATTERY
TEST & CLEAN
REPLACE AS NEEDED

SHOCK ABSORBERS
REPLACE OIL & SEALS

DRIVE BELT
INSPECT & CLEAN
REPLACE AS NEEDED

GENERAL LUBRICATION
ALL FITTINGS, PIVOTS, CABLES, ETC.

AIR FILTER
INSPECT
REPLACE AS NEEDED

300 HRS / 4,828 km

36 MONTHS

ENGINE OIL & OIL FILTER
CHANGE

AIR FILTER
INSPECT
REPLACE AS NEEDED

TRANSMISSION & GEARCASES
REPLACE FLUIDS

CHECK YOUR OWNER'S MANUAL FOR ADDITIONAL RECOMMENDED SERVICE ITEMS AND VEHICLE-SPECIFIC TIMING

90

POLARIS

**ENGINEERED PARTS
& LUBRICANTS**

**FOR THE LIFE OF YOUR RIDE
ONLY THE BEST WILL DO**

To create the best oil for any terrain, we invest in rigorous testing to ensure our oil delivers the consistency and performance you demand. The results are Polaris Engineered Lubricants that are tested and perfected to deliver excellent total engine protection for the life of your ride.

WHAT COUNTS IN OIL TESTING:

1. Does it protect the engine at high temperatures?
2. Does it keep the engine free from carbon and buildup?
3. Does the oil hold its viscosity over time?

ENGINE CHECKPOINTS

When evaluating an engine oil and its ability to protect and preserve the engine's power output and lifespan, Polaris engineers focus on key areas within the engine, some of the most critical ones include:

RING LANDS: Poor oxidative performance can lead to carbon and varnish buildup, which results in poor ring seal and loss of power, combustion blow by and fuel dilution of the oil.

PISTON RINGS: During the combustion process, extreme pressures are placed on the top ring, forcing it outward toward the cylinder wall, sealing the combustion chamber. With so much force applied, poor oil film strength between the top ring and the cylinder wall can lead to cylinder wear and loss of power.

ROD BEARINGS: Engine bearings ride on an extremely thin hydrodynamic film of oil. Poor oil film strength or using an oil with a thinner viscosity, can lead to premature bearing wear or even engine failure. Using an oil with high film strength and a strong viscosity, like PS-4 full synthetic, will extend the service life of your engine.

CAMSHAFT: Direct Acting Overhead Camshafts are used on many Polaris Prostar Engines. In this application the camshaft pushes directly on the valve, creating very high contact pressures compared to other camshaft configurations. These forces are so great that inferior oil can break down and be forced out of the contact area leading to increased wear. PS-4 full synthetic additives are specifically designed to provide wear protection against this.

OIL DEVELOPMENT

12 DEDICATED TEAM MEMBERS	18+ MONTHS
FOCUSED ON POLARIS OIL	DEVELOPMENT & TESTING
64,374 KILOMETERS	75,000+ HOURS
FIELD TESTING	DYNO TESTING



**SPECIFIC NEEDS,
SPECIFIC OILS**

Polaris invests millions in engine development, and part of that investment is making sure its lubricants—critical to engine performance—are the right formula for your specific engine. The amount of testing data and engineering resources used in developing Polaris lubricants would overwhelm an aftermarket company. Therefore, the aftermarket must spec an oil to an industry-wide standard that must account for a variety of operating parameters.

PS-4 is designed specifically for Polaris 4-cycle engines and has high film strength and wear protection under extreme loads and temperatures. Exclusive anti-wear additives protect engine parts with extra rust and corrosion protection.

**PS-4 SYNTHETIC
PERFORMANCE OIL**

• PS-4 is optimal for ambient operating temperatures of -40° C to 40° C

- 11 L • 502484
- 4 L • 502485
- 25 L • 502486
- 60 L • 502487
- 200 L • 502488

PS-4 OIL CHANGE KIT

• Contains the correct amount of oil for your vehicle and correct oil filter

- » 502541
SINGLE 570, TWIN 600, TWIN 700, TWIN 800
- » 502543
RANGER/RZR 900/1000
- » 502542
330500, SPORTSMAN 550/850/1000

**PS-4 EXTREME-
DUTY SYNTHETIC
PERFORMANCE OIL**

• PS-4 Extreme Duty is optimal for ambient operating temperatures of -20° C to 55° C

- 11 L • 502491
- 4 L • 502492
- 25 L • 502494
- 60 L • 502496
- 200 L • 502497

**ENGINEERED TO MAXIMIZE
THE LIFE OF YOUR RIDE**

All Polaris fluids—from anti-freeze to brake fluid—are developed for your vehicle. Trust the only fluids perfectly engineered for your needs.

DOT 4 BRAKE FLUID

Polaris DOT 4 Brake Fluid is a high-quality brake fluid designed for use in Polaris hydraulic brakes. Superior high-temp characteristics plus anti-corrosive additives extend the life of brake system components and provide consistent, positive braking.

» 250 mL • 502526

ANTI-FREEZE

Polaris Extended Life Coolant contains organic acid technologies to prevent corrosion on metal components, eliminate scaling, and maximize cooling system performance.

» 1L • 502566
» 25 L • 502567
» 206 L • 502568

AGL

A proprietary blend of additives designed to optimize Polaris' ORV transmission life. Extreme pressure additives protect gears, drive chain, and bearings from scoring and wear. Unlike typical gear case oils, AGL's unique viscosity range allows instant flow and film protection in extreme cold or high heat environments.

» 1L • 502505
» 25 L • 502507
» 200 L • 502508

DEMAND DRIVE FLUID

Engineered specifically for Polaris ORV front drive systems. Provides positive 4WD engagement in extreme cold or high heat conditions. Unique friction additives protect internal components under heavy loads and promote positive engagement.

» 1L • 502563
» 25 L • 502564
» 200 L • 502565

Proper lubricant application and timing will ensure optimal vehicle performance. Please refer to your owner's manual for lubricant change interval schedules.

<p>CARBON CLEAN</p> <p>Polaris Carbon Clean prevents ethanol corrosion, stabilizes fuel, and cleans fuel injectors, piston ring lands, intake systems, and combustion chambers. Helps maintain peak HP and improves fuel economy.</p> <p>» 125 mL • 502528</p>	<p>FUEL STABILIZER</p> <p>Fuel Stabilizer prevents ethanol corrosion and stabilizes fuel for up to 2 years. Dual-antioxidant formula protects against gum and varnish for easy starting.</p> <p>» 125 mL • 502519</p>	<p>ANGLE DRIVE FLUID</p> <p>» 1L • 502510 » 25 L • 502511 » 202 L • 502512 SPORTSMAN, RANGER, RZR ANGLE DRIVE GEAR CASE SYSTEMS</p>	<p>PREMIUM GAS SHOCK OIL</p> <p>» 1L • 502518</p>
<p>ALL-SEASON GREASE TUBE</p> <p>» 400 g • 502538</p>			

PARTS & GARAGE

MAINTENANCE

OIL & LUBRICANTS

MAINTENANCE
FLUIDS

BATTERIES & GARAGE
ACCESSORIES

HO PARTS

SERVICE PARTS

TIRE SEALANT
& TRAILERING

POLARIS POWER

MAINTENANCE

MAINTENANCE

HD HEAVY DUTY PARTS

All Polaris parts are developed and tested to help you get the most out of your ride. We're taking the passion of our riders, workers and outdoor enthusiasts to the next level with HD Parts.

Engineered and designed for:

- Greater durability
- Enhanced performance
- Greater wear and tear capabilities
- All weather conditions



NEW OIL FILTERS

The advanced synthetic material built into these filters offers the highest debris holding capacity, maintains oil flow and maximizes performance.

OE	HD HEAVY DUTY PARTS
2520799	2522485
2540086	2522498



WHEEL BEARINGS

Fully sealed for added protection against intrusions. Made of a higher grade steel for extended life in extreme conditions.

LOCATION	OE	HD HEAVY DUTY PARTS
FRONT WHEEL BEARINGS	3514924	3515090
REAR WHEEL BEARINGS	3414924	3515090



WHEELS & TIRES

Class leading durability for off-road performance and traction for confident driving in extreme conditions.

- » 1524022-458 • HD WHEEL - 14x7*
- » 5417507 • PRO ARMOR HD-K - 29x10R14*
- » 5457498-458 • HD WHEEL CENTER CAP*
- » 5415756 • PRO ARMOR XD-K FRONT
- » 5415757 • PRO ARMOR XD-K REAR

* SHOWN



NEW DRIVE BELTS

The enhanced rubber material compound in these belts keep them cool in extreme heat, while our proprietary cord treatment process maximizes the transfer of horsepower to the ground for those customers hauling heavy loads.

OE	HD HEAVY DUTY PARTS
3211148	3212326
3211113	3212328



BUSHINGS

The advanced material compound of the bushings enables tighter tolerances to reduce overall wear on the system, while the superior triple lip sealing prevents intrusion of the elements.



LOCATION	OE	HD HEAVY DUTY PARTS
FRONT UPPER BUSHINGS	5439874	1543367
	5439730	1543326
	5436973	1543326
FRONT LOWER BUSHINGS	5439874	1543367
	5439730	1543326
	5436973	1543326
REAR UPPER BUSHINGS	5439874	1543367
	5439730	1543326
	5436973	1543326
REAR LOWER BUSHINGS	5439874	1543367
	5439730	1543367
UPPER HUB BUSHINGS	5436832	1543367

BRAKES

Engineered to provide longer life and better stopping power while riding in extreme conditions.

OE	HD HEAVY DUTY PARTS
2205949	2208933
2203318	2208936
2202413	2208934
2202412	2208935

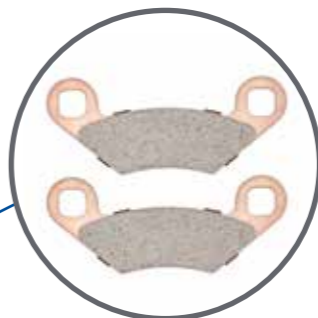

BUSHING KITS

Easily update the entire front and rear suspension.

» 2830564
RZR 800 '08-'14, RZR 800 S '09-'14

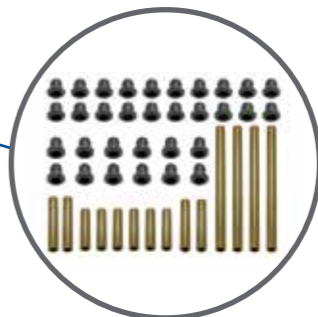

Claims made based off testing and performance of Polaris HD Parts against standard OEM parts made by Polaris and competitor brands under normal use.

For more information regarding Polaris HD parts including vehicle compatibility, installation and maintenance, please contact your authorized Polaris ORV dealer.

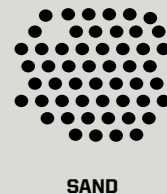

SAND



MUD



WATER



EXTREME COLD



EXTREME HEAT UP TO 54° C



HEAVY PAYLOADS

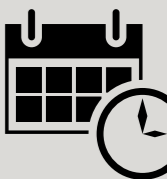

EXTENDED LIFE

PARTS & GARAGE

MAINTENANCE

OIL & LUBRICANTS

MAINTENANCE FLUIDS

BATTERIES & GARAGE ACCESSORIES

HD PARTS

SERVICE PARTS

TIRE SEALANT & TIRE LININGS

POLARIS POWER

SERVICE PARTS

Polaris Engineered service parts deliver unmatched performance and fit for your off-road vehicle.

All service parts are engineered specifically for your machine. Which means everything is designed, tested and perfected to maximize the life of your ride. Getting Polaris Engineered parts is a decision that pays off in the long run, because it ensures there is a long run.



VISIT YOUR POLARIS DEALER TO SHOP FOR SERVICE PARTS.

OVER
100,000
PARTS
AVAILABLE!



FOR THE LIFE OF YOUR RIDE

Maintenance is the key to keeping your Polaris off-road vehicle performing at its peak. Items like belts, lubricants, and batteries represent only a few of these critical items engineered specifically by Polaris.



POLARIS ENGINEERED DRIVE BELTS

TESTED, PERFECTED

We test each belt on the intended vehicle – we don't just try to make an existing belt "just work".

– Amery Kuhl, Polaris CVT System Engineer

OUR INVESTMENT

- 32,187 km of field testing
- Thousands of dyno hours
- 18+ months of development (3,000+ design hours) per belt
- 1,200+ vehicle validation hours
- Collaboration with powertrain & clutch engineers

YOUR ADVANTAGE

- No clutch recalibration
- Less wear & tear due to heat
- Ensure maximum performance of your vehicle
- More time out riding, less time wrenching

**OUR INVESTMENTS ENSURE POLARIS BELTS
OUTPERFORM YOUR EXPECTATIONS.**

CV BOOT REPAIR KIT*

FIX ON THE GO | TEMPORARY COVERAGE

- A quick trail-side fix to increase trail time
- The flexible and durable boot material expands "over a cone tool for CV boot repairs, without disassembling CV axles
- Universal fit - works as a temporary fix for most powersports axles
- All components fit inside the cone, and a cover is provided for compact durable storage
- Easily fits in a cargo box, attached to the roll cage, in the glovebox or many other storage locations



Items shown are contained inside cone

UTV CV BOOT REPAIR KIT

Kit includes the following items:

- (1) Expandable XL CV Boot
- (1) Reusable Cone Tool
- (2) CV Boot Clamps
- (1) Tube of Silicone Lube
- (1) Grease Packet
- (1) Cone Cover

» 2830526

UTV TRAIL BOOT ONLY

» 2830527

ATV

- CV REPAIR KIT 2830528
- TRAIL BOOT ONLY 2830529

HOW TO INSTALL

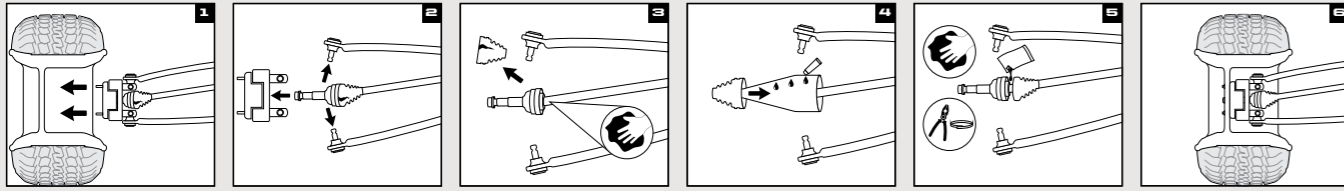

- Remove wheel and axle nut.
- Remove brake caliper, hub, tie rod and upper and lower ball joints.
- Remove old boot and clean joint.
- Spread silicone lube on entire cone tool. Slide boot over cone tool, large end first. See package for outer boot instructions.
- Empty the bag of grease into the CV joint/boot, clean sealing points and install clamps.
- Reassemble tie rod, ball joints, brake caliper, axle nut, tire and wheel.

Refer to your service manual for further instructions and torque specifications.
*Designed for temporary CV boot repair. Purchase the OEM CV Boot for a permanent repair.

KEEP IT CLEAN

CLEAN

ALL-PURPOSE CLEANER

- Professional cleaner, which is formulated with a low pH-value. The product spreads well on surfaces and adheres on them for effective cleaning action. Perfectly compatible with rubber, plastic and painted surfaces. The formulation is biodegradable.

» 500 mL • 502309

SHINE

INSTANT SHINE & DETAILER

- The INSTANT SHINE AND DETAILER is developed for cleaning action without water. Removes insects, dust and dirt with almost no effort. Applicable for plastics, visors, windscreens, paint and metal. The wipe and shine formulation makes surfaces shine, works water repellent and also has an antistatic effect. Perfect for customers living in urban areas with no access to water, for bike trips or showroom bikes.

» 500 mL • 502303



TRAILERING



CALIBER RAMP PRO

- Designed for ATVs and UTVs up to 127 cm wide
 - Integrated grip glides for ultimate traction
 - Folding sides for easy transportation and storing
- » 132 cm x 229 cm • 2884576



ALUMINUM ARCHED LOADING RAMP

- Capacity for up to 1,361 kg
- » 193 cm x 30.5 cm • 907 kg • 2875384
- » 224 cm x 30.5 cm • 1,361 kg • 2875386



LIGHTWEIGHT TRI-FOLD RAMP

- Ramp folds up for transport
- Capacity for up to 681 kg
- Safety straps included
- » 183 cm x 130 cm • 2875385
- » 208 cm x 130 cm • 2875860



FOLDING ALUMINUM ARCHED RAMP

- Ramp folds up for transport
- Up to 680 kg total capacity, 340 kg per individual ramp
- Safety straps included
- » 224 cm x 30.5 cm • 2875387

HITCHES

3:1 HITCHES

VERSATILE 3 IN 1 FUNCTIONALITY

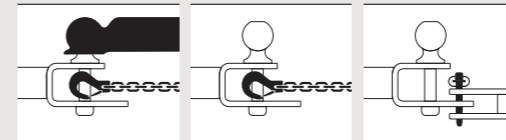

- Ball, hook and pin design
- Durable, rust resistant steel with black powdercoated finish
- Removable ball
- HD 1.6 cm pin and clip



HITCH WITH 5 cm BALL

- 5 cm x 5 cm RECEIVER 2830522
- 3 cm x 3 cm RECEIVER 2830523



4.8 cm BALL

- 4.8 cm replacement ball for hitch
 - Designed to work with 3:1 Hitch
- » 2830524



RECEIVER HITCH

- 5 cm RECEIVER TONGUE 2875320



TRAILER BALL 1.9 cm SHANK

- 4.8 cm BALL • 2877602
- 5 cm BALL • 2877603

STRAPS & ROPES



RECOVERY STRAP

- 5 cm x 9 m
 - 8,165 kg maximum load / 4,082 kg maximum vehicle weight
 - Comes with carry bag
- » 2884033



SPARE TIRE RATCHETING Y-STRAP

» 2689506



RATCHET STRAP

- 5 cm x 6.1 m Ratchet Straps
 - Heavy duty webbing, floating D-rings, double J-hooks
 - 4,536 kg maximum load, 1,497 kg working load
- » 2884032



RATCHET STRAP

- 3.8 cm x 4.6 m straps, 2-Pack
 - Heavy duty webbing
 - 2,495 kg maximum load, working load
- » 2884031



SHOCK STRAP

- 3.8 cm 1,361 kg breaking strength
 - Keeps tension on tie-down straps to secure load
 - 2-Pack
- » 3.8 cm x 4.6 m • 2883296



SHOCK STRAP

- 3.8 cm 1,361 kg breaking strength
 - Keeps tension on tie-down straps to secure load
 - 2-Pack
- » 3.8 cm x 2.1 m • 2883295

COVERS

TRAILERABLE COVER BY POLARIS

- 4-SEAT • 2883989 PRO XP 4 '20-22
- 2-SEAT • 2885092 TRAIL S '21-22, TRAIL '21-22
- 2-SEAT • 2880325 900 '14-20
- 2-SEAT • 2876526 570 '12-22
- 2-SEAT • 2883764 PRO XP '20-22
- 2-SEAT • 2880327 S 900 '15-20, S 1000 '16-20, 900 '15-20
- 2-SEAT • 2879373 XP TURBO '16-21, XP 1000 '14-22
- 4-SEAT • 2879949 XP 4 TURBO '16-21, XP 4 1000 '14-22
- 4-SEAT • 2880326 S 4 1000 '19-21





APPAREL

Take your pick from our wide assortment of comfortable and stylish riding gear and casual wear. You'll find jerseys, t-shirts, sweatshirts, jackets, ballcaps and more that reflect your unique style on and off the trail.





TECHNICAL JACKET

- Water-resistant jacket
- Ultra-light thanks to polyester ripstop and softshell for optimal comfort
- Ventilated lining
- Hydration hose outlet
- Zip ventilation system on body and back

Black | S-3XL | 2802001



TECHNICAL PANTS

- Water-resistant pants
- Ultra-light thanks to polyester ripstop, softshell and 1000-D Cordura Stretch fabric on the back for optimal comfort
- 2 cargo type pockets
- Zip ventilation system
- Zip and Velcro adjustment at the bottom of the pants

Black | S-3XL | 2802002



RACING SOFTSHELL

- Softshell waterproof and breathable 3000mm/3000g
- Removable hood
- Four external pockets with easy-grab puller

Black | S-3XL | 2802003



HYBRID JACKET

- Sleeves in softshell waterproof and breathable 3000mm/3000g
- Body nylon downproof
- Padding 80 g
- Three external pockets with easy-grab puller

Black | S-3XL | 2802004



NEW TECHNICAL SHIRT

- 100% polyester
- Indelible sublimated graphics
- Hemmed edging
- Lycra cuffs and collar

Black | S-3XL | 2802104



NEW BODYWARMER

- Upper body and side panels in softshell waterproof and breathable 3000mm/3000g
- Lower body Nylon downproof
- Padding 80 g
- Two external pockets with easy-grab puller

Black | S-3XL | 2802101



RAIN JACKET

- Polyester ripstop high tearing resistance
- PU coating 1000 mm
- Mesh lining
- Non-removable hood

Black | S-3XL | 2802005



NEW SAFETY GLOVES TOUCH CE

- CE-approved motorcycle glove EN 13594:2015
- Touch screen compatible
- Silicon print on fingers to improve grip
- Neoprene cuff with Velcro tightening
- Reinforcements patches for safety and comfort

Black | XS-7, 3XL-13 | 2802103



NEW SF TECH GLOVES TOUCH CE

- CE-approved motorcycle glove EN 13594:2015
- Touch screen compatible
- Knuckle-protected
- Silicon print on fingers to improve grip
- Neoprene cuff with Velcro tightening
- Reinforcements patches for safety and comfort

Black | XS-7, 3XL-13 | 2802102



NEW
OFF-ROAD RIDING JERSEYS

Mesh ventilated panels for maximum airflow
Elastic sleeves with non-restrictive cuffs

NEW
OFF-ROAD RIDING GLOVES

Adjustable wrist closure for a custom fit
Silicon finger grips and neoprene knuckle protection



BLACK
JERSEY | S-3XL | 2862718
GLOVE | S-3XL | 2862726

ORANGE
JERSEY | S-3XL | 2862719
GLOVE | S-3XL | 2862729

TEAL
JERSEY | S-3XL | 2862720
GLOVE | S-3XL | 2862727

GREEN
JERSEY | S-3XL | 2862721
GLOVE | S-3XL | 2862730

BLUE
JERSEY | S-3XL | 2862722
GLOVE | S-3XL | 2862728

YOUTH JERSEY
S-XL | 2862723

YOUTH JERSEY
S-XL | 2862724

YOUTH JERSEY
S-XL | 2862725



SHORT SLEEVE
Men's | S-3XL | 2860634
Women's | S-3XL | 2860636

LONG SLEEVE
Men's | S-3XL | 2860638
Women's | S-3XL | 2860640



RAIN JACKET
Gray | S-3XL | 2869527

RAIN PANTS
Gray | S-3XL | 2869528

COOLING SHIRTS

FABRIC TECHNOLOGY DESIGNED TO KEEP YOU COOL

- Chemical-free fabric, Coolcore reduces the surface temperature up to 30% so you don't overheat
- Carries a 50 Ultraviolet Protection Factor rating, blocking 98% of harmful UV rays



RAIN JACKET & PANTS

PACKABLE WATERPROOF PROTECTION AGAINST UNPREDICTABLE WEATHER

- 100% waterproof, lightweight and packable nylon
- YKK zippers
- Rain jacket has removable hood

FOR
POLARIS

NEW
TAN
XS-4XL
2862472



ALTITUDE

509 ALTITUDE 2.0 HELMET

LIGHTWEIGHT DESIGN, PERFORMANCE-INFUSED STYLE AND FEATURES WITH ALL-DAY COMFORT

SHELL

- Strong, lightweight construction of carbon fiber or fiberglass

WEIGHT

- Composite as low as 1,260g
- Carbon fiber as low as 1,150g

FEATURES

- Superior fit for all-day comfort
- Removable Pro Series breath box provides excellent ventilation and air flow
- One-piece eyepoint creates draft-free seal with 509 goggles
- Magnetic Fidlock chin-strap technology and integrated GoPro mount
- DOT- and ECE 22.05-approved

FIDLOCK.



BLACK
XS-4XL
2861469



BLACK/RED
XS-4XL
2861472



RED/BLACK
XS-4XL
2861470



CARBON FIBER
BLACK/LIME
XS-4XL | 2861473

FOR
POLARIS

RED/BLACK
XS-4XL
2862467



TACTICAL

NEW TACTICAL 2.0 HELMET

BUILT FROM THE GROUND UP WITH INNOVATIVE FEATURES FOR ULTIMATE COMFORT AND CONTROL

SHELL

- Shock-resistant, injection-molded thermoplastic

FEATURES

- Venturi vent system generates negative pressure at velocity and pulls moist air from the breath box
- Integrated eyepoint seal is co-integrated with the breath box and creates a draft-free seal with 509 goggles for unparalleled warmth and clear field of view
- Magnetic Fidlock chin-strap technology
- DOT- and ECE 22.06-approved

FIDLOCK.



MATTE BLACK
XS-4XL
2862468



GRAY
XS-4XL
2862469



LIME
XS-4XL
2862470



ORANGE
XS-4XL
2862471



LIME
XS-2XL
2861559

TENACITY

TENACITY 4.0 HELMET

COMBINATION OF MODERN STYLE AND PREMIUM PROTECTION WITH INCREDIBLE VALUE

SHELL

- Shock-resistant, injection-molded thermoplastic

WEIGHT

- 1,500g

FEATURES

- Through-flow, full-helmet ventilation
- ProClip quick release chin strap allows you to fasten the chin strap in seconds
- Removable breath box
- Tool-less adjustable roost shield
- Removable, washable liner
- DOT- and ECE 22.05-approved



BLACK
XS-2XL
2861557



BLACK/GRAY
XS-2XL
2861558



BLACK/WHITE
XS-2XL
2861560



WHITE/RED
XS-2XL
2861561



PINK
XS-2XL
2861562



ORANGE
2862561



LIME
2862559

NEW 509 KINGPIN OFF-ROAD GOGGLE

PREMIUM MATERIALS, ATTRACTIVE PRICE



FEATURES

- Oversized spherical lens delivers optimal peripheral vision
- Metal tear-off posts provide strength and durability
- Quick-change technology allows you to run the best lens tint for conditions



BLUE
2862562



STEALTH
2862560

NEW 509 MX6 OFF-ROAD GOGGLE

SUPER WIDE FIELD OF VIEW, ENGINEERED FOR DIRT



FEATURES

- PC outer lens with anti-scratch coating, and internal anti-fog coating
- Outriggers with latch system for quick lens change
- 45mm strap with silicone to hold strap in place



BLACK
2862557



RED/BLACK
2862558

> MEN'S APPAREL

BLACK
S-3XL | 2862569



NAVY
S-3XL | 2862570

NEW
RED
S-3XL | 2862451



BLACK
S-3XL | 2861434

GRAY
S-3XL | 2861435

NEW WORK VEST

RUGGED AND DURABLE VEST THAT'S IDEAL AS AN OUTDOOR LAYER

- Coated with Durable Water Repellency (DWR) to provide water-resistance
- 3M Thinsulate for added warmth with brushed flannel trim
- Three outer pockets for storage

SOFTSHELL JACKET

VERSATILE LIGHTWEIGHT JACKET THAT'S SURPRISINGLY WARM AND PERFECT FOR EVERYDAY WEAR

- Casual jacket armed with rugged and warm features for everyday wear
- Superior DWR prevents precipitation from saturating the jacket's exterior
- Lined with 280g of soft fleece for warmth
- Removable hood and underarm venting, three external pockets and one internal chest pocket



CHARCOAL
S-3XL | 2860865



BRONZE
S-3XL | 2860864

FLANNEL JACKET

SHERPA FLEECE LINED JACKET DELIVERS EXCEPTIONAL WARMTH AND COMFORT

- Warm sherpa lined fleece material
- Insulation to keep you warm
- Plenty of storage for your valuables



FOREST GREEN
S-3XL | 2860862

GRAY
S-3XL | 2860863

BLACK
S-3XL | 2861608

WORK JACKET

WARM AND RUGGED JACKET THAT'S TOUGH FOR WORK AND STYLISH FOR PLAY

- Coated with Durable Water Repellency (DWR) to provide water-resistance
- Built in action back for increased range of motion
- 80g 3M Thinsulate for added warmth with brushed flannel trim
- One inner and four outer pockets for storage

NEW REVOLVE VEST

REVERSIBLE

DURABLE AND WARM REVERSIBLE VEST OFFERS TWO STYLES IN ONE

- Durable windbreak outer fabric helps protect from the elements
- 140g 3M Thinsulate insulation keeps you warm in cold weather
- Reversible vest offers two unique styles in one



BLUE/ORANGE
S-3XL | 2862566

BLACK/GRAY
S-3XL | 2862565



NEW WINDBREAKER JACKET

LIGHTWEIGHT, WINDPROOF JACKET THAT PROVIDES PROTECTION WHILE RIDING

- 100% polyester windproof fabric
- Lightweight construction makes it easy to pack
- Three external pockets allow for maximum storage

Black | S-3XL | 2861541



FORCE JACKET

PACKABLE JACKET OFFERS LIGHTWEIGHT PROTECTION, IDEAL FOR ANY ACTIVITY

- 140g 3M Thinsulate
- Plenty of storage with two external hand pockets and one internal media pocket
- Rugged YKK zippers
- Great for travel, compacts into pocket

Black | S-3XL | 2861432



BLUE/ORANGE
S-3XL | 2862567

NEW
TITAN MID-LAYER

EXTREMELY WARM YET BREATHABLE
MID-LAYER, PERFECT FOR RIDING

- 319g Polartec Thermal Pro rib sweater provides great warmth
- Quick drying moisture wicking helps keep you dry
- Breathable material moves sweat to the outer surface
- Nylon overlay is comfortable and light

BLACK
S-3XL | 2862568



NEW
TAN
S-3XL | 2862450

RED/BLACK
S-3XL | 2862490



NORTHSTAR MID-LAYER

VERSATILE MID-LAYER CAN BE WORN
ALONE OR AS AN EXTRA LAYER

- 280g of breathable fleece for added warmth
- Offers durable protection against the elements with a wear-resistant polyester face and wind-block layer on chest
- Designed to fit under outer shell when riding

BLACK/RED
S-3XL | 2862616

BLACK/GRAY
S-3XL | 2869925

NEW
JOURNEY HOODIE

DURABLE HOODIE DESIGNED FOR EVERY DAY WEAR

- Keeps the elements out with snug, rib-knit waist and cuffs
- Mock neck collar provides added protection and warmth
- Durable blended material made of 80% cotton, 20% polyester

BLACK
S-3XL | 2862489



TECH FULL-ZIP HOODIE

NEW Tan | S-3XL | 2862486
Gray | S-3XL | 2861493
Black/Blue | S-3XL | 2861494



CREW SWEATSHIRT

NEW Black | S-3XL | 2862488
Green | S-3XL | 2861498
Navy | S-3XL | 2861497



ICON HOODIE

NEW Gray | S-3XL | 2862487
Green | S-3XL | 2861495
Black | S-3XL | 2861496



ICON LONG SLEEVE

NEW Gray/Red | S-3XL | 2862505
Black | S-3XL | 2861584
Blue | S-3XL | 2861585



DASH LONG SLEEVE

NEW Gray | S-3XL | 2862504
Navy | S-3XL | 2861583
Black | S-3XL | 2861582



CHECKERED LONG SLEEVE

NEW Red | S-3XL | 2862506
Gray | S-3XL | 2861587
Black | S-3XL | 2861586



ICON TEE

NEW Green | S-3XL | 2862501
Black | S-3XL | 2861570
Blue | S-3XL | 2861571



STAMP TEE

NEW Black | S-3XL | 2862496
Gray | S-3XL | 2861565
Green | S-3XL | 2861564



CORE TEE

NEW Red | S-3XL | 2862502
Black | S-3XL | 2861572
Blue | S-3XL | 2861573

> MEN'S APPAREL

RZR TECH HOODIE

Black/Red | S-3XL | 2861544
 Gray/Blue | S-3XL | 2861545



RZR FULL ZIP HOODIE

Charcoal Heather | S-3XL | 2860720
 Black | S-3XL | 2860719



RZR LOGO HOODIE

Navy/Orange | S-3XL | 2869586
 Gray/Lime | S-3XL | 2860704
 Black/Red | S-3XL | 2869587



RZR VAPOR HOODIE

NEW Black | S-3XL | 2862495
 Gray | S-3XL | 2869593



RZR AIR TEE

Black | S-3XL | 2869591



RZR LONG SLEEVE

NEW Red | S-3XL | 2862508
 Royal | S-3XL | 2861935
 Black | S-3XL | 2861934

RZR TEE

NEW Gray | S-3XL | 2862509
 Black/Red | S-3XL | 2861936
 Royal | S-3XL | 2861937

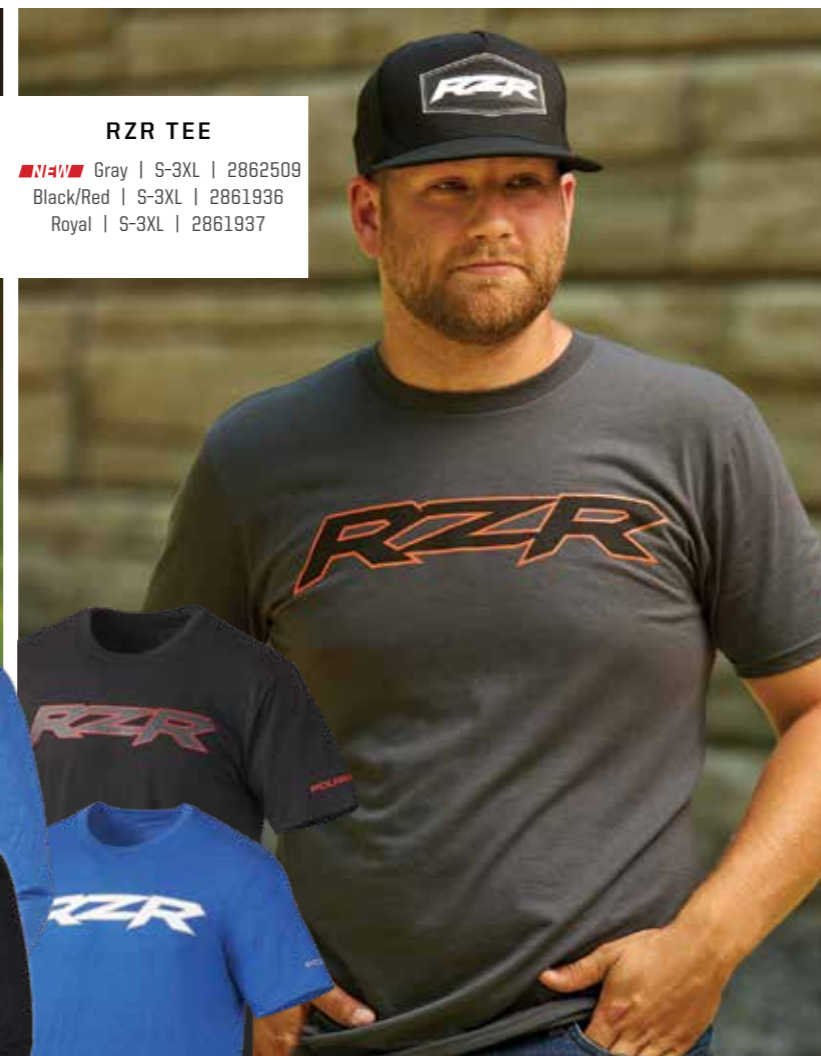

NEW
RZR BOLT TEE

Navy | S-3XL | 2862510



RZR EDGE TEE

Gray | S-3XL | 2861940
 Black | S-3XL | 2860729



NEW
RZR PRO CAP

Gray | One Size | 2862546



RZR PATCH HAT

Gray/Blue | S/M | 2861547
 Gray/Blue | L/XL | 2861548
 Black/Red | S/M | 2860607
 Black/Red | L/XL | 2860608



RZR FLAT BILL

NEW Gray | One Size | 2862547
NEW Black | One Size | 2862596
 Navy | One Size | 2861546

APPAREL

RIDING GEAR

HELMETS & GOGGLES

MEN'S APPAREL

WOMEN'S APPAREL

MERCHANDISE

> MEN'S CAMO

STEALTH CAMO HAT

Camo | One Size | 2861527



NORTHSTAR MID LAYER

Camo | S-3XL | 2861542



CAMO SOFTSHELL JACKET

Camo | S-3XL | 2861543

> MEN'S BALL CAPS



ELLIPSE PATCH TRUCKER HAT

NEW Light Gray | One Size | 2862539
 Gray | One Size | 2861531
 Black | One Size | 2861533
 Navy | One Size | 2861532

NEW HIGHLAND CAP

Tan | One Size | 2860893
 Gray | One Size | 2862544



NEW CAMO REVOLVE VEST

Camo | S-3XL | 2862572



NEW PURSUIT HOODIE

Camo | S-3XL | 2862494



CAMO NECK GAITER

Camo | One Size | 2861948



CORE CAP

NEW Gray | One Size | 2862594
 Navy | One Size | 2861523
 Black | One Size | 2861524



TONAL HAT

Black/Red | One Size | 2861526
 Navy | One Size | 2861525



NEW CLASSIC CAP

Gray | One Size | 2862543
 Navy | One Size | 2862597



CAMO TRUCKER HAT

Black | One Size | 2860613



HUNTER ORANGE HAT

Orange | S/M | 2860892
 Orange | L/XL | 2862545



HUNTER ORANGE BEANIE

Orange | One Size | 2862595



CHECKERED HAT

Blue | One Size | 2861520
 Black | One Size | 2861522
 Gray | One Size | 2861521



RETRO CAP

NEW Navy | One Size | 2862538
 Gray/Red | One Size | 2869542
 Gray/Orange | One Size | 2861536

> WOMEN'S APPAREL

NEW
BLUE
S-3XL | 2862460



BLACK
S-3XL | 2862563



BLACK
S-3XL | 2861437

GRAY/BLUE
S-3XL | 2861439



BLUE
S-3XL | 2862564

SOFTSHELL JACKET

LIGHTWEIGHT PERFORMANCE THAT'S SURPRISINGLY WARM AND PERFECT FOR EVERYDAY WEAR

- Superior DWR prevents precipitation from saturating the jacket's exterior
- Lined with 280g of soft fleece for warmth
- Removable hood and underarm venting, three external pockets and one internal chest pocket

NEW WORK JACKET

WARM AND RUGGED JACKET THAT'S TOUGH FOR WORK AND STYLISH FOR PLAY

- Coated with DWR to provide water-resistance
- Built-in action back for increased range of motion
- 80g 3M Thinsulate for added warmth with brushed flannel trim
- One inner and four outer pockets for storage



BLACK
S-3XL | 2862457

DUSTY ROSE
S-3XL | 2862456



BLACK
S-3XL | 2861433



BLACK/GRAY
S-3XL | 2862458

DUSTY ROSE
S-3XL | 2862459

NEW REVOLVE VEST

DURABLE AND WARM REVERSIBLE VEST OFFERS TWO STYLES IN ONE

- Durable windbreak outer fabric protects you from the elements
- 140g 3M Thinsulate insulation keeps you warm in cold weather
- Reversible vest offers two unique styles in one

FORCE JACKET

PACKABLE JACKET OFFERS LIGHTWEIGHT PROTECTION, IDEAL FOR ANY ACTIVITY

- 140g 3M Thinsulate
- Plenty of storage with two external hand pockets and one internal media pocket
- Rugged YKK zippers
- Great for travel, compacts into pocket

NEW TITAN MID-LAYER

EXTREMELY WARM YET BREATHABLE MID-LAYER, PERFECT FOR RIDING

- 319g Polartec Thermal Pro rib sweater provides great warmth
- Quick drying moisture wicking helps keep you dry
- Breathable material moves sweat to the outer surface
- Nylon overlay is comfortable and light



NEW JOURNEY HOODIE

Black | S-3XL | 2862515
Blue | S-3XL | 2862516



TECH FULL-ZIP HOODIE

NEW Navy | S-3XL | 2862511
Gray | S-3XL | 2861508
Maroon | S-3XL | 2861509



ICON HOODIE

NEW White | S-3XL | 2862512
Black | S-3XL | 2861506
Maroon | S-3XL | 2861507



NEW ADVENTURE CREW

Dusty Rose | S-3XL | 2862513
Black | S-3XL | 2862514



NEW ADVENTURE TEE

Teal | S-3XL | 2862629
Black Frost | S-3XL | 2862628



THINK OUTSIDE TEE

NEW Pink | S-3XL | 2862518
Black | S-3XL | 2861590
Blue | S-3XL | 2861591



NEW RZR LIGHTWEIGHT HOODIE

Dusty Rose | S-3XL | 2862571
Sage | S-3XL | 2862731



RZR TANK TOP

Black | S-3XL | 2861945
Gray | S-3XL | 2861944



RZR SCENIC TEE

Gray | S-3XL | 2861943
Maritime | S-3XL | 2860715
Black | S-3XL | 2860714

APPAREL

RIDING GEAR

HELMETS & GOGGLES

MEN'S APPAREL

WOMEN'S APPAREL

MERCHANDISE



STEEL SIGN
35.6 cm x 91.4 cm | 2860868



ALUMINUM SIGN
55.9 cm | 2860867



WOOD SIGN
26.7 cm x 61 cm | 2860866



PINT GLASSES (SET OF 2)
2860815



12oz CAMPER MUG
2861612



17oz WATER BOTTLE
2861611



NEW
23oz WATER BOTTLE
2862685



15oz CAMPFIRE MUG
2861613



KEYCHAIN
2861614



LEATHER LOOP KEYCHAIN
2861615



NEW
LICENSE PLATE HOLDER
2862687



NEW
KICKBACK ROCKER
2862626



NEW
FREESTYLE ROCKER
2862625



NEW
EASY CHAIR
2862627



NEW
QUICK-E-SEAT
2862624



NEW
FOLDING TABLE
2861620



NEW
POLARIS PARKING SIGN
2869934



NEW
POLARIS FLAG
91.4 cm x 152.4 cm | 2869928



NEW
HITCH COVER
2861623





MAKE IT YOUR RZR

DUNES

LIGHTING	P. 54
RZR SUBZERO 4-PT HARNESS	P. 84
PRO ARMOR WHEELS & TIRES	P. 64
ROOFS	P. 32
DOORS	P. 31

MUD

PRO ARMOR WHEELS & TIRES	P. 64
WINCH & MIRRORS	P. 28
DOORS	P. 21
ROOFS	P. 20
LIGHTING	P. 24
AUDIO	P. 16
STORAGE / COOLERS	P. 26

ROCK

PRO ARMOR WHEELS & TIRES	P. 64
VEHICLE PROTECTION	P. 32
WINCHES	P. 86
MIRRORS	P. 35
RIDE COMMAND	P. 60

Availability varies by market, check your local dealer for availability. Images taken on private land. The use of vehicles in similar environments in your jurisdiction may be prohibited per locally applicable laws and regulations. Campfires in similar environments in your jurisdiction may be prohibited per locally applicable laws and regulations. Keep your campfire safe, and make sure you can control it at all times. Know your locally applicable laws and regulations. Crossing water in similar environments may be prohibited in your jurisdiction.

Warning: Polaris off-road vehicles can be hazardous to operate and are not intended for on-road use. Driver must be at least 16 years old with a valid driver's license to operate. All riders should always wear helmets, eye protection and protective clothing and footwear. Read, understand and follow your owner's manual. Ride within the limits of your own abilities and never engage in stunt or exhibition driving. Never ride under the influence of drugs or alcohol. All riders should take a safety training course. Call 800-342-3764 for additional information.

UNLESS NOTED, TRADEMARKS ARE THE PROPERTY OF POLARIS INDUSTRIES INC. 3M® and Thinsulate® are registered trademarks of 3M Company. 509® is a registered trademark of Teton Outfitters, LLC. App Store® is a registered trademark of Apple Inc. BatteryMinder® is a registered trademark of VDC Electronics Inc. Bluetooth® is a registered trademark of Bluetooth Sig, Inc. Caliber® is a registered trademark of Caliber Products Inc. COOLCORE® is a registered trademark of COOLCORE LLC. CREE® is a registered trademark of Cree, Inc. Facebook® is a registered trademark of Facebook, Inc. FANG® is a registered trademark of CIRO, LLC. Fidlock® is a registered trademark of Fidlock GmbH. Google Play® is a registered trademark of Google LLC. GoPro® is a registered trademark of GoPro Inc. High Lifter® is a registered trademark of NIVEL PARTS & MANUFACTURING CO. NOCO® and NOCO GENIUS® are registered trademarks of The Noco Company. Instagram® is a registered trademark of Instagram, LLC. KING OF THE HAMMERS® is a registered trademark of Hammering Productions, Inc. MB Quart® is a registered trademark of Maxxsonics USA Inc. Pandora® is a registered trademark of Pandora Media, LLC. Polartec® is a registered trademark of MMH-IPCO, LLC. Proline Wraps® are a registered trademark of Andrew Madrid. RIGID® is a trademark of JST Performance, LLC d/b/a Rigid Industries. Rockford Fosgate® is a registered trademark of Rockford Corporation. S&B® is a registered trademark of S&B Filters, Inc. SMART BOARD® is a registered trademark of MART TECHNOLOGIES ULC UNLIMITED LIABILITY CORPORATION CANADA. Sparco® is a registered trademark of Sparco S.P.A. TEKVEST® is a registered trademark of 1181676 ONTARIO INC. The Mint 400® is a registered trademark of THE MINT 400 CORPORATION. Tiger Drylac® is a registered trademark of TIGER COATINGS GMBH & CO. Twitter® is a registered trademark of Twitter, Inc. Velcro® is a registered trademark of VELCRO BVBA PRIVATE LLC BELGIUM. WALKER EVANS RACING® is a registered trademark of Walker Evans Enterprises Incorporated. Yeti® is a registered trademark of Yeti Coolers, LLC. YKK® is a registered trademark of YKK Corporation. YouTube® is a registered trademark of Google Inc. Prices, Fitment and Availability are subject to change at any moment. COPYRIGHT © 2021 POLARIS INDUSTRIES INC. ALL RIGHTS RESERVED.

RIDE OF YOUR LIFE



POLARIS

MY22.5 RZR APP ACC EMEA